



ESSENTRA

COMPONENTS



DES MILLIERS DE CAPES ET BOUCHONS : **ESSAYEZ AVANT D'ACHETER**

- Un large choix de modèles, de dimensions et de matières adaptés à vos applications
- Facile à monter et à démonter pour offrir une solution simple et efficace
- Contactez-nous afin de discuter de vos besoins, nous trouverons la pièce qu'il vous faut.

www.essentracomponents.fr



CAPES ET BOUCHONS

CAPES/BOUCHONS CONIQUES



018

BOUCHONS À PRESSION



026

CAPES À PRESSION



041

BOUCHONS FILETÉS



052

CAPES FILETÉES



060

CAPES/BOUCHONS CONIQUES

Cape/Bouchon conique

SR 1000

Polyéthylène basse densité rouge

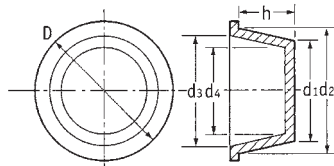

- S'utilise comme bouchon ou comme cape
- Facile à monter et à démonter
- Plus de 140 tailles disponibles
- Excellente protection contre les chocs, la poussière, l'humidité et la corrosion durant le stockage et le transport

Référence	Dimensions (mm)						Qté par sac
	d1	d2	d3	d4	D	h	
10836	2.9	4.6	3.0	1.3	7.9	9.5	10000
10991	4.4	6.1	4.5	2.8	9.5	9.5	10000
50222	4.7	8.5	5.7	2.5	11.7	22.5	10000
12419	5.6	7.0	5.4	4.0	10.5	8.4	10000
10727	6.2	7.6	5.9	5.0	11.1	9.5	10000
12482	7.7	9.3	7.0	5.5	12.7	8.0	10000
10549	7.7	9.1	7.7	6.3	12.7	9.5	10000
10289	8.4	10.0	8.2	6.9	13.5	9.5	10000
12562	8.6	10.3	8.2	7.0	13.7	9.8	10000
12483	9.0	10.7	8.8	7.5	13.9	11.5	10000
10325	9.4	10.8	9.3	7.7	14.0	8.5	10000
10750	10.0	11.8	10.0	8.5	15.0	9.5	10000
12420	10.6	12.2	10.0	8.6	15.6	9.8	10000
10114	10.9	12.3	10.7	9.1	15.9	9.3	10000
12421	11.2	14.0	12.1	9.2	17.5	18.5	5000
12422	11.3	12.9	10.9	9.4	16.3	8.5	10000
10421	11.3	13.2	11.6	9.8	17.0	11.0	10000
10174	11.5	13.0	11.5	10.0	16.7	9.5	10000
12901	12.0	14.8	12.0	10.5	17.5	11.0	5000
10237	12.1	13.9	12.3	10.6	17.5	11.0	5000
12563	12.5	14.0	12.0	10.5	17.5	8.9	5000
15137	12.8	15.1	13.2	10.7	18.5	23.1	4000
10438	13.6	15.3	13.7	12.1	19.0	11.2	5000
10342	14.2	16.0	14.4	12.7	19.0	12.1	5000
10424	14.7	17.0	15.4	13.2	20.6	12.7	5000
12481	14.9	16.4	14.5	13.5	21.0	11.5	5000
12423	15.5	17.1	15.0	13.4	20.6	8.5	5000
12564	16.1	17.6	15.5	14.5	21.0	8.5	5000
11139	16.4	18.3	16.9	14.3	22.2	12.3	5000
12196	16.6	18.5	16.5	14.5	21.9	13.0	6000
110197	17.1	19.4	17.8	15.5	22.0	13.0	6500
12197	17.2	20.2	18.0	15.5	24.2	18.0	4000
110198	17.5	20.1	18.5	15.9	24.0	14.5	5000
11088	17.7	19.6	17.3	15.2	22.2	12.7	5000
10394	17.8	20.0	18.3	16.4	23.8	13.4	5000
12424	18.3	21.4	19.3	16.4	25.4	17.5	4000
10208	18.5	20.9	19.3	17.1	24.6	14.3	5000
10728	19.0	21.5	19.7	17.6	25.8	14.3	4000
12925	19.4	22.5	21.3	18.0	26.5	19.0	3000
12425	20.5	23.2	21.2	18.5	27.2	17.5	3000
52071	21.2	23.2	21.7	19.3	27.3	12.3	4000
10676	21.3	23.2	21.5	19.2	27.0	15.9	3000
110200	22.0	24.8	23.2	20.4	29.0	17.0	3000
10376	22.0	25.0	23.0	20.5	28.5	15.9	3000
12565	22.5	25.5	23.3	20.0	28.9	17.8	3000
12426	22.7	24.9	22.7	20.8	27.0	12.0	3000
10136	23.4	26.4	24.4	21.4	29.3	17.5	2500
12427	24.0	26.9	25.0	21.9	31.0	18.0	2000
12567	24.6	29.5	27.5	22.5	34.0	27.5	1500
10732	24.7	27.7	26.1	23.2	32.0	19.0	2000
110201	25.2	29.2	27.7	23.7	33.0	19.0	1500
12999	26.6	29.7	28.3	24.6	31.6	26.3	1500
10250	28.0	30.9	29.0	26.5	35.3	19.0	2000
11173	29.2	31.2	30.3	28.0	34.7	12.7	2000

Pour filetage	
Comme cape	Comme bouchon
M4	1/4" UNF
M6	M8, 5/16" UNF
1/4" UNF	3/8" UNF
M8	M10
3/8" UNF	M12
1/8" BSP	1/4" BSP, 1/2" UNF
M12	M14 x 1.5
7/16" UNF	9/16" UNF
1/4" BSP, 1/2" UNF	M16
M14	3/8" BSP
M16, 5/8" UNF	M18 x 1.5
3/8" BSP	3/4" UNF
M18 x 1.5, M18 x 2	M20 x 1.5
3/8" BSP	1/2" BSP
M18	M20
3/4" UNF	1/2" BSP
M20 x 2.5, 1/2" BSP	M22 x 1.5
M22 x 1.5	M22 x 1.5, 7/8" UNF
M22	M24
7/8" UNF	5/8" BSP
M24	1" UNF
M25, 1" UNF	3/4" BSP, M27, M26
3/4" BSP	M28, M30, 1 1/8" UNF
M27, M28	7/8" BSP
M22 x 2	M30 x 1.5

Suite page suivante

Cape/Bouchon conique *Suite*

SR 1000

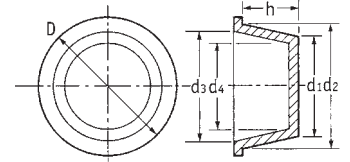

Référence	Dimensions (mm)						Qté par sac
	d1	d2	d3	d4	D	h	
10272	30.0	32.6	30.7	27.5	36.7	15.2	2000
12428	30.5	33.3	31.1	28.4	37.0	14.5	2000
12568	31.1	34.3	32.0	29.3	38.1	17.5	1500
10154	31.1	34.4	32.8	29.8	38.1	19.0	1500
12569	31.6	36.3	34.0	29.8	40.2	24.1	1000
11167	33.3	34.4	32.8	31.4	38.1	9.5	2500
10181	33.3	37.2	35.6	31.7	41.6	22.2	1000
12480	33.9	38.3	36.5	31.9	42.3	24.5	1000
10838	33.9	37.3	35.8	32.0	42.2	12.3	2000
12198	34.9	36.4	35.2	33.1	42.7	8.2	2500
12570	35.9	40.2	37.5	33.2	44.1	24.5	1000
15138	36.3	38.3	37.0	34.6	42.3	12.0	1500
10491	36.9	40.6	39.0	35.0	44.0	22.5	1000
11115	38.6	40.6	39.0	37.1	44.5	12.7	1500
10485	39.6	42.7	41.1	38.2	47.6	18.5	1000
12429	40.8	44.7	41.8	37.7	49.0	24.0	500
10252	41.4	44.8	43.0	39.7	49.2	19.0	1000
11172†	42.5	44.8	43.0	40.7	50.7	12.6	1000
15139	43.4	48.5	47.0	42.0	53.3	24.5	600
10812	44.1	46.7	45.7	42.8	49.8	18.4	800
110204	44.4	47.7	46.1	42.8	51.0	19.0	1500
10168	45.2	49.0	47.0	43.7	53.4	24.5	600
10439	45.9	46.3	45.0	44.3	50.8	9.5	1500
15136	46.0	50.0	48.0	44.3	54.0	24.8	500
12430	47.2	51.9	48.7	44.5	55.8	24.0	500
11131	47.5	50.3	49.0	45.2	54.0	25.0	500
10820	48.0	52.7	50.7	46.3	57.1	25.4	500
10086	48.6	51.2	48.9	46.7	55.5	18.7	500
12746	49.8	54.0	52.0	47.5	58.0	24.3	500
10624	51.1	54.4	52.0	47.7	57.0	25.0	500
10935	51.5	54.1	52.0	49.6	58.3	18.5	500
11047	53.5	57.0	55.3	51.2	62.4	25.1	400
12431	54.0	58.4	55.0	50.8	62.4	24.5	400
10616	55.0	61.0	59.0	52.2	65.0	25.0	400
11168	55.4	58.8	57.2	53.7	65.0	25.1	400
11169	57.5	57.6	56.1	55.2	63.6	12.8	700
11100	59.3	67.3	64.1	56.7	70.3	31.7	300
10249	59.6	62.6	61.0	57.0	66.7	24.6	300
11075	62.0	66.4	64.3	59.0	71.0	28.0	300
10292	63.3	69.8	67.8	61.5	73.0	25.4	400
10399	64.5	67.3	65.6	62.1	70.6	15.8	400
11064	68.1	70.9	69.3	66.3	74.6	19.0	400
10302	70.0	75.8	74.0	68.1	79.4	25.4	300
10617	74.0	77.0	73.9	71.5	82.5	18.7	300
10550	74.0	76.8	73.4	70.0	80.0	24.4	600
11023	76.8	82.2	80.8	74.8	85.7	25.4	500
11170	77.1	80.7	78.2	74.8	85.7	19.0	300
11037	80.0	86.1	82.0	77.5	89.8	25.1	500
10353	84.2	90.8	88.3	82.7	94.5	28.0	500

Pour filetage	
Comme cape	Comme bouchon
M30	M33,1" BSP
7/8" BSP	1 5/16" x 12 UNF
M33, M32, 1 1/4" UNF	1 3/8" UNF, M36
1 5/16" BSP	M36
	1 5/16" BSP
1" BSP	M38, 1 1/8" BSP
1 3/8" UNF	1 1/8" BSP
M38	1 1/4" BSP
1 1/2" UNF	M42
M39, M40	
1 1/4" BSP	M45 x 2
M45 x 1.5/2/3	M48 x 2, 1 7/8" JIC/UNF, 1 1/2" BSP
1 3/8" BSP	M48, 1 1/2" BSP
	M48
M48, 1 1/2" BSP	M52
1 3/4" BSP	M56, M55
M58	2" BSP
2" BSP	
	M76, M75, 2 1/2" BSP
2 1/2" BSP	
3" BSP	

† Six anneaux supplémentaires confèrent une adhérence parfaite si cette cape est utilisée comme bouchon

Suite page suivante

CAPES/BOUCHONS CONIQUES

Cape/Bouchon conique *SUITE*

SR 1000

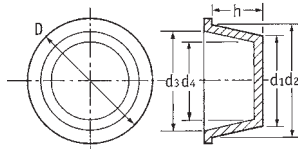

Recommandations

Si utilisé comme cape, la dimension d4 doit être inférieure d'au moins 0.5mm/centimètre par rapport au diamètre à couvrir. Pour couvrir les diamètres de plus de 30mm, ce chiffre demandera peut-être une révision à la hausse.

Si utilisé comme bouchon, la dimension d2 doit être plus large d'au moins 0.5mm/centimètre par rapport à l'orifice. Pour les diamètres de plus de 30mm, ce chiffre demandera peut-être une révision à la hausse.

Référence	Dimensions (mm)						Qté par sac
	d1	d2	d3	d4	D	h	
11171	85.3	88.0	85.5	82.9	92.0	19.0	250
12572	87.5	93.6	90.5	84.3	96.7	34.3	250
10304	88.1	93.3	89.9	85.1	96.5	28.6	300
10253	92.1	97.0	94.0	88.3	100.0	32.0	300
10697	93.5	100.3	97.8	89.9	107.5	26.5	400
462569	96.5	102.0	101.0	94.0	110.0	31.0	200
12573	94.5	100.6	97.0	91.0	103.6	34.5	100
12199	98.0	102.0	98.5	94.8	107.2	24.7	400
10551	98.2	103.3	99.0	95.0	106.0	28.8	300
110785	101.0	107.0	103.0	98.0	109.0	28.6	300
10688	101.9	107.5	103.0	98.0	109.0	28.6	300
10771	106.7	111.7	107.4	107.4	113.3	28.6	250
10455	108.0	114.1	111.6	106.4	118.5	35.2	250
462570	109.0	113.0	111.0	106.0	123.0	27.0	175
10837	110.0	115.0	109.0	105.0	118.5	28.0	250

Référence	Dimensions (mm)						Qté par sac
	d1	d2	d3	d4	D	h	
12574	111.5	117.6	115.0	107.5	122.0	35.0	250
10133	112.1	114.3	109.8	107.5	116.8	28.6	250
10355	124.0	128.0	125.0	121.0	134.0	23.0	150
12575	129.0	135.1	132.0	124.0	139.5	36.5	150
462571	133.0	137.0	134.2	130.2	143.0	22.0	150
12576	139.5	145.6	140.0	135.0	150.0	36.5	150
10356	146.8	151.0	148.6	142.8	159.5	33.0	100
39649	153.7	161.5	160.0	152.0	178.9	29.6	135
12577	156.0	162.3	158.8	151.8	167.3	36.7	100
39196*	202.9	203.8	198.8	198.0	218.7	32.7	100
462572	203.5	208.5	205.9	200.9	216.0	24.0	60
39666	216.0	223.6	223.0	213.0	241.5	29.1	100
39195*	252.2	257.8	247.8	247.2	272.5	33.8	50
39149*	304.2	308.4	299.4	299.2	322.6	33.9	30

* PEBD noir

Capés et bouchons haute résistance

PEBD

Rouge/Blanc*

- Cette conception robuste inclut une paroi solide et une bague d'étanchéité pour une protection maximale
- La forme conique permet d'obturer de multiples diamètres intérieurs ou de couvrir différents diamètres extérieurs

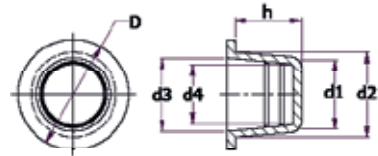

Référence	Dimensions (mm)						Qté par sac
	d1	d2	d3	d4	D	h	
GP607A	7.4	8.3	6.3	5.5	13.5	9.5	5000
GP610A	8.1	9.9	7.2	5.4	14.3	11.1	5000
GP617A	11.1	12.7	10.7	8.9	16.4	11.1	4000
GP628A	16.7	19.2	16.8	13.7	23.4	16.5	5700
GP632A	19.5	21.6	18.8	15.5	26.5	15.9	4200
K1838A*	20.8	22.8	20.4	18.0	28.4	16.2	2000
GP642A	27.8	29.0	26.6	23.4	34.5	16.0	2200
GP648A	30.6	34.4	30.5	29.2	38.9	19.1	1500
GP650A	33.1	35.2	32.6	30.6	41.3	19.1	1400
GP652A	35.0	36.6	34.1	31.4	43.0	19.1	1300
GP654A	36.8	38.7	36.0	34.1	44.0	19.1	1200
GP656A	38.3	40.1	37.2	34.2	46.2	19.1	1000
GP658A	39.6	41.6	39.2	36.6	47.6	19.1	1000
GP660A	41.0	42.8	40.6	37.5	48.4	19.1	1000
GP662A	42.7	44.5	41.8	39.2	50.8	19.1	800
GP664A	43.9	46.1	44.0	41.7	54.0	19.1	800
GP666A	45.9	47.7	45.0	42.4	56.8	19.1	700
GP668A	47.4	48.8	46.2	43.5	57.6	19.1	700
GP670A	49.0	51.0	48.0	46.1	59.7	19.1	600
GP672A	50.0	51.7	49.4	46.0	60.9	19.1	600
GP674A	51.8	54.1	52.0	49.4	62.7	19.1	600
GP676A	53.6	55.4	53.6	51.1	63.5	19.1	500

Cape et bouchon conique - Large collerette

SR 1001

Polyéthylène basse densité rouge

- Vient compléter la gamme SR1000 des capes et bouchons
- Large collerette pour une meilleure protection et un démontage plus facile

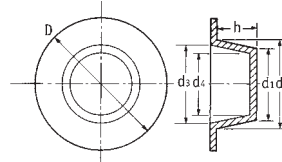

Référence	Dimensions (mm)						Qté par sac
	d1	d2	d3	d4	D	h	
12432	7.6	9.3	7.7	6.3	18.4	9.5	10000
12433	10.7	12.3	10.7	9.1	22.0	9.5	10000
10420	11.3	13.2	11.6	9.8	29.0	11.0	10000
110831	11.4	12.4	10.5	9.5	15.0	7.0	2000
12434	13.5	15.5	13.2	11.4	30.0	9.5	5000
18349	13.6	15.4	13.8	12.2	22.2	11.1	8000
18351	14.7	16.9	15.4	13.2	25.4	12.7	6000
12435	17.5	20.0	18.5	16.1	34.9	14.3	3000
18356	19.1	21.5	19.9	17.6	38.1	14.3	2500
12436	21.9	25.0	22.0	18.9	48.0	17.5	1500
12134 *	22.5	25.3	23.5	20.8	55.4	17.3	3000
18357	24.7	27.7	26.1	23.2	38.1	19.1	1500
12437	30.4	33.6	30.7	27.8	47.3	15.2	1400
18360	31.1	34.4	32.8	29.8	47.6	19.1	1000
12438	33.3	37.2	35.6	32.0	50.8	22.2	800
12439	36.9	40.6	39.0	35.0	54.2	22.5	800
18362	41.4	44.8	43.0	39.7	57.2	19.0	700
12441	47.2	51.9	48.7	44.5	72.0	24.0	400
18366	48.3	52.7	50.7	46.3	63.5	25.4	1200
18368	51.5	54.1	52.0	49.6	66.7	18.5	500
18373	55.0	61.0	59.0	52.5	76.7	25.0	300
18374	62.0	66.4	64.3	59.0	83.0	28.0	250

Pour filetage	
Comme cape	Comme bouchon
-	-
1/8" BSP	1/4" BSP, 1/2" UNF
-	-
-	-
1/4" BSP, 1/2" UNF	M16, 5/8" UNF
-	M18
M18	1/2" BSP
-	-
-	-
-	M27, M30
M30	M33, M32, 1" BSP
M33, M32, 1 1/4" UNF	M35
M35, 1" BSP	M36, M38, 1 1/8" BSP 1 1/2" UNF
M38, 1 1/8" BSP	M39, M40, 1 1/4" BSP
M42, 1 1/4" BSP	M45
-	-
M48, 1 3/4" BSP	M52
-	-
-	-
-	-

* Fourni avec trou d'évent

Cape et bouchon conique - Large collerette

SR 1115

Polyéthylène basse densité bleu

- Large collerette pour une meilleure protection et un démontage plus facile

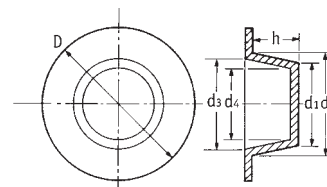

Référence	Dimensions (mm)						Qté par sac
	d1	d2	d3	d4	D	h	
LF2A	4.4	6.1	4.5	2.8	14.3	11.8	5500
LF-3	6.0	7.4	6.2	3.7	12.3	10.2	5000
LF-6	9.3	10.6	9.0	7.6	18.8	10.2	5000
LF-7	10.1	11.4	9.7	8.3	19.8	10.2	5000
LF8A	10.8	12.1	10.7	9.0	20.62	10.2	4750
LF9A	11.2	12.9	11.4	9.5	20.83	11.8	7500
LF-10	12.2	13.9	12.5	10.4	22.1	11.7	7000
LF11A	13.5	15.6	14.5	11.9	23.88	11.9	5000
LF-11X	14.4	16.0	14.7	12.7	24.1	12.5	5000
LF12A	14.7	16.7	15.4	13.2	24.97	13.4	4500
LF-12X	15.5	17.5	16.1	13.9	26.2	13.4	4500
LF15A	17.5	19.7	18.3	15.7	28.58	14.2	3500
LF-15X	18.4	20.6	19.4	16.8	29.0	15.0	3000
LF16A	19.2	22.1	20.5	17.6	30.1	14.7	3000
LF-17	20.8	23.4	22.0	18.8	31.8	15.8	2300
LF18A	22.0	24.8	23.2	20.4	32.54	16.5	4000
LF-19	24.1	25.9	24.3	22.2	34.1	18.2	1500
LF20A	25.0	28.1	26.4	23.4	36.5	18.9	3000
LF22A	31.4	35.1	33.3	29.6	42.85	18.9	2000
LF23XA	33.3	37.2	36.2	31.8	46.86	19.7	1700
LF24A	36.8	40.7	39.4	35.1	49.23	18.9	1500
LF-28	43.9	48.0	46.4	41.9	58.7	18.9	1100

Cape et bouchon conique - bleu

SR 1111

Polyéthylène basse densité bleu

- S'utilise comme bouchon ou comme cape
- Facile à monter et démonter
- Excellente protection contre les chocs, la poussière, l'humidité et la corrosion durant le stockage et le transport

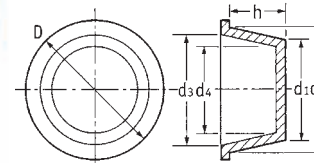

Référence	Dimensions (mm)						Qté par sac
	d1	d2	d3	d4	D	h	
1	2.9	4.6	3.0	1.3	7.9	10.3	5000
15	3.5	4.6	3.0	1.3	7.9	6.4	5000
2	4.5	6.1	4.5	2.8	9.5	9.5	5000
3	5.3	6.8	4.9	3.2	9.5	9.5	5000
5	6.1	7.7	6.1	4.5	11.9	9.5	5000
6	6.7	8.5	7.0	5.2	11.9	9.5	5000
7	7.6	9.3	7.7	5.9	13.5	9.5	5000
7-S	8.4	9.3	7.7	6.8	12.7	5.6	5000
8	8.4	10.1	8.4	7.0	14.3	9.5	5000
9	9.1	10.9	9.3	7.6	15.1	9.5	5000
10	9.9	11.7	10.1	8.3	15.9	9.5	5000
11	10.7	12.3	10.7	9.0	15.1	9.5	5000
12	11.4	13.0	11.4	9.8	15.9	10.3	5000
13	12.5	13.9	12.3	10.4	18.3	12.7	5000
13-SP	12.1	13.8	12.2	10.4	18.3	7.9	5000
13-W	12.1	13.9	12.3	10.4	22.2	12.7	7000
14	12.7	14.4	12.8	11.1	19.1	11.1	5000
16	13.5	15.8	14.1	11.9	19.1	11.8	7500
17	14.0	16.1	14.4	12.3	19.8	12.7	7500
18	15.0	17.2	15.4	13.2	22.2	13.5	5000
20	15.5	17.7	16.1	13.9	21.4	12.7	6000
21	16.3	18.5	16.9	14.6	22.2	12.7	5000
22	17.2	19.2	17.5	15.6	22.2	15.9	4000
23	17.5	19.9	18.4	15.9	23.8	15.9	4000
26	18.4	21.0	19.3	16.8	25.4	12.7	4000
26-L	18.4	21.0	19.3	16.8	24.6	15.0	8000
27	19.1	21.5	19.7	17.4	26.2	15.9	7000
28	20.4	23.1	21.5	18.4	27.8	19.1	5000
29	20.8	23.7	21.6	19.2	28.6	14.6	5500
30	21.7	24.7	23.0	19.5	28.6	19.1	4500
31	22.1	24.8	23.4	20.4	28.6	15.9	5000
35	22.7	26.4	24.8	21.1	29.4	19.1	4500
38	24.9	26.5	25.0	22.3	31.8	12.7	2500
40	24.5	27.7	26.0	22.9	31.8	19.1	3500
41	25.5	29.1	27.4	23.8	33.3	19.1	3500
42	28.2	31.2	30.0	26.4	38.5	19.1	2500
44	30.0	32.6	30.9	28.1	36.5	19.1	2500
45	31.1	34.3	32.9	29.5	38.1	19.1	2500
46	31.4	34.3	32.9	29.0	36.5	19.1	2500
47	32.8	34.6	33.02	31.2	38.1	19.1	2000
48	32.8	37.0	35.3	31.2	41.3	25.4	1500
49	33.3	37.3	35.6	31.7	41.3	19.1	2000
51	34.1	38.5	36.8	32.6	44.5	23.8	1500
53	36.8	40.6	39.0	35.2	44.5	19.1	2000
54	38.6	40.7	39.0	37.0	45.2	19.1	1700
K-5	38.7	38.7	37.7	36.7	44.5	12.7	2500
55	39.6	42.5	41.2	38.0	47.6	19.1	1500
56	40.8	44.5	42.8	39.8	49.2	19.1	1500
57	44.1	47.5	46.2	42.6	51.6	19.1	1200
58	45.9	49.7	48.1	44.3	54.0	25.4	900
59	45.7	46.4	44.7	44.1	51.6	12.7	2000
60	46.9	51.3	49.2	45.3	54.0	25.4	1000
62	48.3	53.0	51.2	46.7	57.2	25.4	850
63	50.3	55.1	53.6	48.6	57.2	25.4	800

SUITE PAGE SUIVANTE

Cape et bouchon conique - bleu SUITE

SR 1111

Polyéthylène basse densité bleu

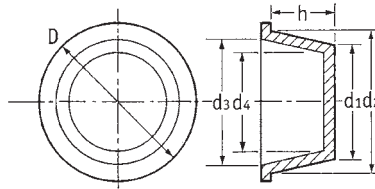

Référence	Dimensions (mm)						Qté par sac
	d1	d2	d3	d4	D	h	
65	51.2	54.5	52.9	49.7	58.7	19.1	1000
66	52.4	57.2	55.3	50.8	61.9	26.2	700
67	54.8	59.8	58.1	52.9	66.7	25.4	600
68	56.5	57.9	56.4	54.6	63.5	12.7	1200
70	54.1	61.6	60.2	51.9	63.5	25.4	700
71	58.4	63.1	61.0	56.8	66.7	25.4	600
73	60.8	66.2	64.5	59.2	66.7	25.4	600
74	61.7	67.2	65.5	61.5	69.9	19.1	700
75	58.7	67.3	65.7	57.0	69.9	25.4	750
76	62.4	69.9	68.2	60.8	73.0	25.4	600
77	65.0	68.3	66.7	63.5	73.0	19.1	700
78	67.2	71.3	69.2	65.5	76.2	12.7	1000
81	69.1	76.2	74.9	66.7	79.4	25.4	500
82	72.4	75.7	74.2	70.7	82.6	19.1	500
83	76.1	80.2	78.7	74.0	85.7	12.7	750
85	75.7	82.4	80.4	73.7	85.7	25.4	400
86	78.5	85.5	83.4	76.3	88.9	25.4	400
87	84.3	87.6	85.6	82.3	92.1	12.7	500
88	82.2	90.8	88.8	80.2	100.0	25.4	300
89	88.0	91.4	89.2	86.5	98.4	22.4	350
90	93.4	96.5	94.7	91.6	101.6	19.1	300
91	96.5	99.7	97.7	94.4	104.8	17.5	300
92	99.5	103.4	101.1	96.8	111.1	19.8	250
93	102.4	106.4	104.4	100.3	114.3	19.1	250
94	107.1	112.9	111.3	105.0	123.8	25.4	200
95	110.9	117.0	114.3	109.0	127.0	25.4	200
1100	124.7	129.3	127.3	122.7	139.7	26.2	250
1110	126.8	132.1	129.5	125.0	143.0	26.2	250
101	138.9	142.8	140.7	136.9	155.7	25.4	100
103	143.3	149.2	147.2	140.7	158.8	25.4	100
39665	141.0	150.0	148.0	138.0	164.1	25.4	140
FPL-6*	152.0	153.4	-	-	167.9	32.5	150
104	152.7	157.0	154.9	150.4	168.2	25.4	90
106	162.6	166.6	164.6	160.8	176.3	22.9	100
108	167.9	170.4	168.4	165.9	182.6	38.9	100
K-436	174.8	178.6	176.5	172.7	194.8	13.5	300
110	179.1	180.9	178.8	177.0	193.8	26.2	100
112	186.4	194.3	192.0	184.4	201.7	26.2	100
114	194.6	199.1	197.1	192.5	206.3	26.2	100
118	207.2	212.1	209.6	204.5	222.3	35.7	50
120	213.4	218.4	215.9	210.8	228.6	35.7	50
124	220.2	221.7	219.1	217.2	231.9	38.9	50
126	230.1	237.7	234.7	225.8	250.4	45.2	50
130	274.1	281.9	277.1	268.0	294.6	45.2	40
133	303.0	319.0	313.7	297.2	331.5	51.6	30
134	324.9	338.8	328	318.3	346.5	51.6	30
136	336.6	345.4	340.4	330.2	358.1	51.6	30

* Noir

Bouchon conique fermé

SR 1114

Polyéthylène basse densité bleu

- Pour taraudage BSP / NPT conique

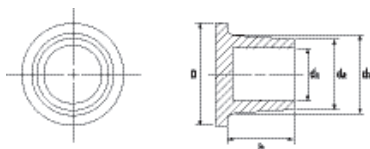

Référence	Filetage BSP / NPT	Dimensions (mm)					Qté par sac
		d1	d2	d3	D	h	
EN-1/4	1/4"	9.0	10.7	12.3	15.5	7.1	5000
EN-3/8	3/8"	12.7	14.0	16.3	19.5	12.7	6500
EN-1/2	1/2"	15.9	17.5	19.9	23.0	12.7	4000
EN-3/4	3/4"	20.6	22.1	24.8	27.8	15.9	2500
EN-1	1"	26.2	27.7	30.5	34.1	16.7	1500

Bouchon conique avec languette à anneau

SR 1174

PEBD jaune

- Peut s'utiliser comme bouchon ou comme cape
- Profil conique pour s'adapter à de nombreuses dimensions
- Démontage facile de la pièce avec languette à anneau solide

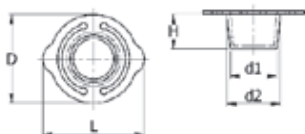

Référence	Dimensions (mm)					Qté par sac
	d1	d2	H	D	L	
498716	5.0	7.0	9.5	17.3	20.3	1000
498717	6.0	8.0	9.5	18.2	21.1	1000
498718	7.0	9.5	9.5	20.3	23.3	1000
498719	8.0	10.0	9.5	20.3	23.2	1000
498720	9.5	11.5	9.5	21.9	24.8	1000
498721	10.5	12.5	9.5	22.6	26.5	1000
498722	11.5	13.5	9.5	23.7	27.5	1000
498723	12.5	14.5	10.0	24.5	28.4	1000
498724	13.5	15.5	10.0	25.5	29.5	1000
498725	14.2	16.2	10.0	26.3	30.3	1000
498726	14.5	17.0	10.0	27.0	31.0	500
498727	15.5	18.0	10.0	28.3	32.0	500
498728	17.5	19.5	10.0	30.0	34.0	500
498729	18.0	20.0	10.0	30.0	34.0	500
498730	19.0	21.5	11.0	32.0	35.7	500
498731	21.0	24.2	11.0	34.7	38.7	500
498732	22.5	25.5	12.0	36.0	40.0	500
498733	25.0	28.0	12.0	38.5	42.2	500
498734	29.0	31.5	12.0	41.8	47.0	500
498735	29.5	32.0	12.0	42.5	47.6	500

NOTRE GAMME ÉTENDUE DE CAPES ET BOUCHONS...

...également disponible en
petits conditionnements



www.essentracomponents.fr

Bouchon à languette centrale

SR 1068

Polyéthylène basse densité rouge

Référence	Pour filetage			Dimensions (mm)					Qté par sac
	Métrique	UNF	BSP	d1	d2	D	h	H	
110029	M8	5/16"	-	6.2	7.7	11.1	9.5	20.5	10000
CP-6*	-	-	-	6.8	8.5	11.9	10.3	15.9	5000
110030	M10	7/16"	1/8"	8.4	10.0	13.5	9.5	20.5	10000
110031	-	3/8"	-	9.5	10.8	14.0	9.5	20.5	10000
CP-9*	-	-	-	9.2	10.9	15.1	9.5	19.1	7000
CP-10*	-	-	-	10.2	11.8	15.9	9.5	19.1	6000
110032	M12	1/2"	1/4"	10.9	12.3	15.9	9.5	20.3	10000
CP-12*	-	-	-	11.4	13.0	16.7	10.3	14.3	5000
110033	M14	9/16"	-	11.7	13.7	17.2	11.0	22.0	5000
CP-14*	-	-	-	12.7	14.4	18.3	11.9	20.6	7500
110034	M16	5/8"	3/8"	14.2	16.0	19.0	11.9	22.9	5000
CP-18*	-	-	-	14.7	17.0	20.6	13.5	19.1	5500
CP-19*	-	-	-	15.5	17.7	21.3	13.5	19.8	5000
110035	M20	3/4"	-	16.4	18.3	22.2	12.3	23.5	5000
110036	-	13/16"	1/2"	17.8	20.0	23.8	13.7	24.5	5000
CP-24*	-*	-	-	18.5	21.0	25.4	15.0	21.3	5000
110037	M24	7/8"	5/8"	21.3	23.2	27.0	15.9	26.9	3000
CP-31*	-	-	-	22.1	24.7	28.5	19.1	25.4	4000
10418	-	1"	-	22.5	25.5	28.9	17.8	29.0	2500
110038	M28, M30	1 1/8"	-	24.7	27.7	32.0	19.0	30.0	2000
CP-37*	-	-	-	24.6	27.7	31.8	19.8	26.2	2500
CP-40*	-	-	-	26.1	29.1	34.0	19.1	25.4	2500
CP-42*	-	-	-	27.8	31.0	35.8	19.8	25.4	2500
CP-44*	-	-	-	29.2	32.7	39.4	19.1	25.4	2000
CP-47*	-	-	-	32.8	33.2	38.1	19.8	25.4	1800
CP-49*	-	-	-	33.3	37.2	41.2	19.1	25.4	1800
CP-51*	-	-	-	34.1	38.8	44.5	22.4	25.4	1500
CP-55*	-	-	-	36.9	40.7	44.5	19.1	25.4	1500
CP-56*	-	-	-	41.0	44.1	48.4	18.3	28.6	1000
CP-57*	-	-	-	45.9	49.2	54.9	25.4	31.8	1000
110039†	M52	-	-	48.2	52.7	57.1	25.4	26.4	300
110040†	M58, M60	-	2"	55.0	61.0	65.0	25.0	26.0	400
110041†	M62	-	-	59.3	67.3	70.6	30.7	31.5	150
110042†	-	-	-	67.4	70.2	74.6	25.0	26.0	300

† La languette ne dépasse pas de la hauteur du bouchon

* PEBD orange

- Languette centrale facilitant la pose et la dépose
- Excellente protection contre la poussière, l'humidité et la corrosion pendant la production, le stockage et le transport

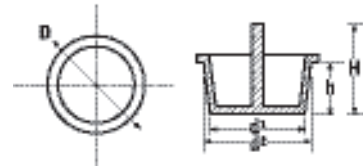

Bouchons à languette

SR 1110

Polyéthylène basse densité bleu

Référence	Dimensions (mm)				Qté par sac
	d1	d2	D	h	
P-7	7.6	9.3	13.5	9.5	5000
P-8	8.4	10.1	14.3	9.5	5000
P-11	10.7	12.3	15.1	9.5	5000
P-16	13.5	15.8	19.1	12.7	7000
P-17	14.0	16.1	19.8	12.7	7000
P-23	17.5	19.9	23.8	15.9	3500
P-26	20.4	23.2	26.9	16.5	5000
P-31	22.1	24.8	28.6	15.9	2500
P-33	23.2	26.4	29.4	18.3	5000
P-40	24.5	27.7	31.8	19.8	3000
P-41	25.3	29.1	33.3	19.8	2500
P-42	28.2	31.2	38.5	19.1	2500
P-44	29.6	32.4	35.7	19.1	2500
P-53	36.8	40.6	44.5	19.1	2000
P-55	39.6	40.6	47.6	19.1	1500
P-57	41.5	44.5	49.3	19.1	1000
P-59	45.7	46.4	51.6	12.7	2000
P-61	45.2	49.5	53.9	25.4	1000
P-63	46.8	50.8	53.9	25.4	1000
P-65	48.2	52.7	57.2	25.4	1000
P-68	56.7	57.4	63.5	12.7	1000

- Peut-être utilisé comme cape ou bouchon
- Bouchon à languette facile à démonter

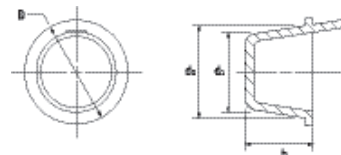

BOUCHONS À PRESSION

Bouchon Moss

SR 1013

PVC noir ou Vinyl vert

- Très bonne résistance à la fragmentation
- Le vinyl vert peut être utilisé pour les huiles et graisses

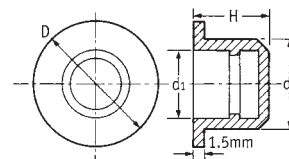

Référence		Dimensions (mm)				Qté par sac
PVC noir	vinyl vert	d1	d2	D	H	
10874	-	1.6	3.2	7.0	8.7	10000
12665	-	3.2	5.0	11.0	12.0	10000
12666	11806	3.1	6.0	12.0	12.0	5000
12667	11817	4.5	7.0	13.0	12.0	5000
12668	11808	4.9	8.0	14.0	12.0	10000
12669	11829	6.1	9.0	15.0	12.0	5000
12670	11807	7.2	10.0	16.0	12.0	5000
12671	11824	8.2	11.0	17.0	12.0	10000
12672	11809	9.2	12.0	20.0	12.0	8000
12673	11822	10.2	13.0	21.0	14.0	8000
12674	11813	11.0	14.0	22.0	14.0	7000
12675	11830	12.2	15.0	23.0	14.0	6000
12677	11820	12.9	16.0	24.0	14.0	6000
12678	11811	14.0	17.0	27.0	14.0	5000

Référence		Dimensions (mm)				Qté par sac
PVC noir	vinyl vert	d1	d2	D	H	
12679	11827	15.0	18.0	28.0	14.0	4000
12680	11818	16.1	19.0	29.0	14.0	2000
12681	11812	17.2	20.0	30.0	14.0	2000
12683	11823	18.0	21.0	31.0	14.0	3000
12684	11828	19.0	22.0	32.0	14.0	1500
12685	11814	20.1	23.0	33.0	14.0	1500
12686	11810	21.6	24.0	34.0	16.0	2500
12687	11816	22.2	25.0	35.0	16.0	2000
12688	11819	23.5	26.0	36.0	16.0	2000
12689	11821	23.6	27.0	37.0	16.0	2000
12690	11825	25.2	28.0	38.0	16.0	2000
12692	11826	27.9	30.0	40.0	16.0	1000
12693	12078	36.4	40.0	50.0	22.0	700
12694	-	43.2	47.0	57.0	22.0	500

Bouchon à bords parallèles

SR 1015

Polyéthylène basse densité transparent

- Bouchon standard à usage général

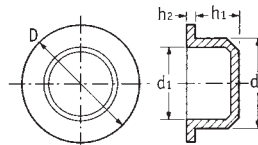

Référence	Dimensions (mm)					Qté par sac
	d1	d2	D	h1	h2	
12150	3.5	5.0	9.0	5.0	1.0	10000
12151	3.6	5.5	9.5	5.0	1.0	10000
12152	4.5	6.0	10.0	5.5	1.0	10000
12153	5.0	6.5	10.5	5.5	1.0	10000
12154	5.5	7.0	11.0	5.5	1.0	10000
12155	5.6	7.5	11.5	5.5	1.0	10000
12156	6.5	8.0	12.0	5.5	1.0	10000
12157	7.0	8.5	12.5	6.0	1.0	10000
12158	7.5	9.0	13.0	6.0	1.0	10000
12159	8.0	9.5	13.5	6.0	1.0	10000
12160	8.5	10.0	14.0	6.5	1.0	10000
12161	9.0	10.5	14.5	6.5	1.0	10000
12162	9.5	11.0	15.0	6.5	1.0	10000
12163	10.0	11.5	15.5	6.5	1.0	10000
12164	10.5	12.0	15.8	6.5	1.0	5000
12165	11.0	12.5	16.5	6.5	1.0	5000
12166	11.0	13.0	17.0	6.5	1.25	5000
12167	11.5	13.5	17.5	6.5	1.25	5000
12168	12.0	14.0	18.0	6.5	1.25	5000
12169	12.5	14.5	18.5	7.0	1.25	5000
12170	13.0	15.0	19.0	7.5	1.25	5000
12171	13.5	15.5	19.5	7.5	1.25	5000
12172	14.0	16.0	20.0	7.5	1.25	5000
12173	14.5	16.5	20.5	7.5	1.25	5000
12174	15.0	17.0	21.0	7.5	1.25	5000
12175	15.5	17.5	21.5	7.5	1.25	5000
12176	16.0	18.0	22.0	8.5	1.25	5000
12177	16.5	18.5	22.5	8.5	1.25	5000
12178	17.0	19.0	23.0	8.5	1.25	5000
12179	17.5	19.5	23.4	8.5	1.25	5000
12180	18.0	20.0	24.0	9.0	1.25	5000
12181	18.5	20.5	24.5	9.0	1.25	5000
12182	19.0	21.0	25.0	9.0	1.25	5000
12183	19.5	21.5	25.5	9.0	1.25	5000
12184	22.0	22.0	26.0	9.0	1.25	5000
12185	20.0	22.5	26.5	9.0	1.5	2500
12186	20.5	23.0	27.0	9.0	1.5	2500
12187	21.0	23.5	27.5	9.0	1.5	1250

Référence	Dimensions (mm)					Qté par sac
	d1	d2	D	h1	h2	
12188	21.5	24.0	28.0	9.0	1.5	2500
12189	22.0	24.5	28.5	9.0	1.5	2500
12190	22.5	25.0	29.0	9.0	1.5	2500
12191	23.5	26.0	30.0	10.0	1.5	2000
465656	24.7	26.6	30.6	8.5	1.4	1000
12192	24.5	27.0	31.0	10.0	1.5	2000
465657	26.0	27.7	31.6	8.5	1.3	1000
12193	25.5	28.0	32.0	10.0	1.5	2000
12194	26.5	29.0	33.0	10.0	1.5	1500
12195	27.5	30.0	34.0	10.0	1.5	1500
465658	29.9	31.1	35.0	8.5	1.3	1000
465659	30.2	31.4	35.5	8.5	1.4	1000
10352	29.0	31.5	35.5	10.0	1.5	1500
465660	30.2	31.8	35.8	8.5	1.4	1000
462590	30.5	32.5	37.0	11.0	1.0	1500
465661	31.7	33.2	37.2	8.5	1.4	1000
465662	34.4	36.0	40.2	8.5	1.4	1000
465663	37.5	39.1	43.1	8.5	1.4	1000
465664	38.0	39.5	46.2	8.8	1.4	1000
462591	37.5	39.5	42.0	11.0	1.0	1000
465665	38.9	40.1	46.8	8.6	0.7	1000
465666	39.1	40.7	47.5	8.7	1.5	1000
465670*	38.3	40.5	54.0	9.6	1.3	750
465667	41.4	42.6	46.4	5.8	1.5	1000
465668	44.5	46.1	52.7	8.5	1.4	1000
462592	45.5	47.0	52.0	10.0	1.0	1000
465672	49.5	51.1	60.0	10.2	1.1	750
465673	56.5	58.2	67.0	8.7	1.1	750
465674	58.8	60.0	61.7	10.2	0.7	750
465675	64.6	66.2	75.2	8.7	1.1	750
465676	72.0	74.0	83.0	8.7	1.2	750
465677	79.4	81.2	90.2	8.7	1.2	500
465678	83.2	85.1	93.8	8.7	1.4	500
465679	84.4	86.6	98.6	9.0	1.3	500
465680	99.5	101.8	113.8	9.0	1.4	500

* Variation de style des brides

Bouchon de protection

SR 1011

PEBD naturel / blanc / noir

- Bouchon pour une large gamme d'application
- Pose et dépose rapide
- 3 modèles disponibles - Corps bombé pour une meilleure tenue



Type 1

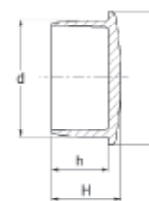

Type 2

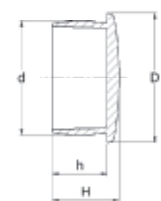

Type 3

Référence	Couleur	Type	Pour filetage	Dimensions (mm)				Qté par sac
				d	D	h	H	
055002200003	Naturel	1	-	2.1	3.5	7.0	-	1000
055002500003	Naturel	1	-	2.6	12.0	4.0	-	1000
055002600003	Naturel	1	-	2.7	12.0	6.0	-	1000
055003200003	Naturel	2	-	3.3	12.0	6.0	7.7	1000
055004400003	Naturel	2	-	4.4	9.0	5.2	6.5	1000
054044911303	Blanc	2	-	4.4	9.0	5.2	6.5	1000
054044922003	Noir	2	-	4.4	9.0	5.0	6.5	1000
055004700003	Naturel	2	-	4.6	7.0	5.0	6.2	1000
054047760003	Blanc	2	-	4.6	7.0	5.0	6.2	1000
054047769903	Noir	2	-	4.6	7.0	5.0	6.2	1000
055005200003	Naturel	2	-	5.1	11.0	6.0	8.0	1000
055005211303	Blanc	2	-	5.1	11.0	6.0	8.0	1000
055005222003	Noir	2	-	5.1	11.0	6.0	8.0	1000
10876	Naturel	2	-	5.4	12.0	7.5	9.5	10000
054054211303	Blanc	2	-	5.4	12.0	7.5	7.5	1000
494365	Noir	2	-	5.4	12.0	7.5	9.5	500
054054560003	Blanc	2	-	5.4	15.0	7.5	-	1000
054054569903	Noir	2	-	5.4	15.0	7.5	-	1000
055006000003	Naturel	2	-	6.0	11.0	7.0	-	1000
054060111303	Blanc	2	-	6.0	11.0	7.0	-	1000
054060122003	Noir	2	-	6.0	11.0	7.0	-	1000
054060260003	Blanc	2	-	6.0	12.0	7.0	-	1000
054060269903	Noir	2	-	6.0	12.0	7.0	-	1000
054060560003	Blanc	2	-	6.0	15.0	7.0	-	1000
054060569903	Noir	2	-	6.0	15.0	7.0	-	1000
1287228	Naturel	1	-	6.3	9.6	4.0	5.1	1000
055006600003	Naturel	2	-	6.6	7.5	5.0	-	1000
055006611303	Blanc	2	-	6.6	7.5	5.0	-	1000
055006622003	Noir	2	-	6.6	7.5	5.0	-	1000
055007000003	Naturel	2	-	7.2	11.0	6.5	8.4	500
054070111303	Blanc	2	-	7.2	11.0	6.5	-	1000
054070122003	Noir	2	-	7.2	11.0	6.5	-	1000
054070260003	Blanc	2	-	7.2	12.0	6.5	-	500
054070269903	Noir	2	-	7.2	12.0	6.5	-	500
054070560003	Blanc	2	-	7.2	15.0	6.5	-	500
054070569903	Noir	2	-	7.2	15.0	6.5	-	500
055007300003	Naturel	2	-	7.3	11.0	6.0	8.0	500
12135	Naturel	1	M8 X 1, 5/16 X 24 UNF	7.3	14.0	6.0	8.0	10000
494366	Noir	1	M8 X 1, 5/16 X 24 UNF	7.3	14.0	6.0	8.0	500
055007500003	Naturel	2	-	7.5	10.7	4.5	6.2	500
055008000003	Naturel	2	-	8.0	12.0	7.5	9.5	500
054080260003	Blanc	2	-	8.0	12.0	7.5	-	500
054080269903	Noir	2	-	8.0	12.0	7.5	-	500
054080560003	Blanc	2	-	8.0	15.0	7.5	-	500
054080569903	Noir	2	-	8.0	15.0	7.5	-	500
12136	Naturel	1	-	8.4	14.0	6.0	8.0	10000
494367	Noir	1	-	8.4	14.0	6.0	8.0	500
055008400003	Naturel	2	-	8.5	12.0	4.0	-	500

SUIITE PAGE SUIVANTE

Bouchon de protection SUITE

SR 1011

PEBD naturel / blanc / noir

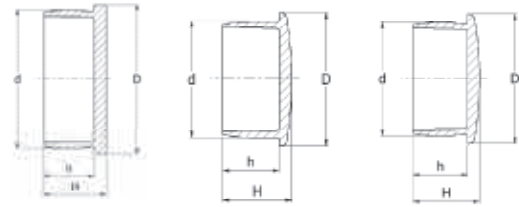

Type 1

Type 2

Type 3

Référence	Couleur	Type	Pour filetage	Dimensions (mm)				Qté par sac
				d	D	h	H	
055008500003	Naturel	2	-	8.5	12.0	8.0	9.7	500
054085211303	Blanc	2	-	8.5	12.0	8.0	-	500
054085222003	Noir	2	-	8.5	12.0	8.0	-	500
054085560003	Blanc	2	-	8.5	15.0	8.0	-	500
054085569903	Noir	2	-	8.5	15.0	8.0	-	500
055008422003	Noir	2	-	8.5	12.0	4.0	-	500
055008411303	Blanc	2	-	8.5	12.0	4.0	-	500
055008800003	Naturel	2	-	8.8	11.5	8.0	9.5	500
055008822003	Noir	2	-	8.8	11.5	8.0	9.5	500
055008811303	Blanc	2	-	8.8	11.5	8.0	-	500
055009300003	Naturel	3	-	9.3	12.0	9.0	11.5	500
055009322003	Noir	3	-	9.3	12.0	9.0	11.5	500
055009311303	Blanc	3	-	9.3	12.0	9.0	-	500
10905	Naturel	1	M10	9.3	14.0	4.5	6.5	6000
494368	Noir	1	M10	9.3	14.0	4.5	6.5	500
12978	Naturel	1	1/8" BSP, M10 X 1.5	9.3	16.0	5.9	8.3	6000
055010100003	Naturel	2	-	10.0	12.0	4.0	5.7	500
054100311303	Blanc	2	-	10.0	12.0	4.0	-	500
054100322003	Noir	2	-	10.0	12.0	4.0	-	500
054100260003	Blanc	2	-	10.0	12.0	9.0	-	500
054100269903	Noir	2	-	10.0	12.0	9.0	-	500
055010000003	Naturel	2	-	10.0	15.0	9.0	11.2	500
054100560003	Blanc	2	-	10.0	15.0	9.0	-	500
054100569903	Noir	2	-	10.0	15.0	9.0	-	500
055010700003	Naturel	3	-	10.5	14.8	9.0	11.4	500
055010722003	Noir	3	-	10.5	14.8	9.0	11.4	500
055010711303	Blanc	3	-	10.5	14.8	9.0	-	500
12977	Naturel	1	M10 X 1.5	10.7	14.0	6.0	8.2	6000
494369	Noir	1	M10 X 1.5	10.7	14.0	6.0	8.2	500
1255331	Naturel	2	M12 X 1.25, M12 X 1	11.3	14.4	5.5	9.5	1000
055011900003	Naturel	3	-	11.9	14.8	8.0	-	500
055011922003	Noir	3	-	11.9	14.8	8.0	-	500
055011911303	Blanc	3	-	11.9	14.8	8.0	-	500
110478	Naturel	1	-	11.9	16.0	7.0	9.0	5000
494370	Noir	1	-	11.9	16.0	7.0	9.0	500
054119860003	Blanc	3	-	11.9	17.5	8.5	-	500
054119869903	Noir	3	-	11.9	17.5	8.5	-	500
10906	Naturel	1	M14 X 1.5	12.3	16.0	7.0	9.0	5000
494371	Noir	1	M14 X 1.5	12.3	16.0	7.0	9.0	500
055012500003	Naturel	3	-	12.8	17.5	9.0	11.9	500
055012522003	Noir	3	-	12.8	17.5	9.0	-	500
055012511303	Blanc	3	-	12.8	17.5	9.0	-	500
12979	Naturel	1	M14 X 1.5	12.8	20.0	7.8	10.3	5000
494372	Noir	1	M14 X 1.5	12.8	20.0	7.8	10.3	500
055013200003	Naturel	3	-	13.2	17.5	8.0	-	500
1287226	Naturel	1	M14 X 1.5, M14 X 1.25	13.3	18.7	7.0	9.0	1000
12787	Naturel	1	M14, 9/16" x 24 UNF	13.7	20.0	8.0	10.0	5000
494373	Noir	2	-	13.7	20.0	8.0	10.0	500

Bouchon de protection SUITE

SR 1011

PEBD naturel / blanc / noir

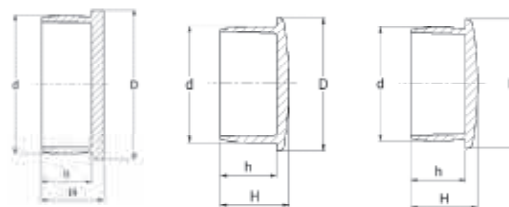

Type 1

Type 2

Type 3

Référence	Couleur	Type	Pour filetage	Dimensions (mm)				Qté par sac
				d	D	h	H	
055013600003	Naturel	3	-	13.9	19.5	9.0	-	500
1255332	Naturel	2	M16 X 1.5	14.0	18.7	7.0	9.0	1000
12089	Naturel	2	M16	14.5	20.0	5.5	7.5	5000
494374	Noir	1	M16	14.5	20.0	5.5	7.5	500
055014300003	Naturel	3	-	14.9	18.5	9.0	11.7	500
055014322003	Noir	3	-	14.9	18.5	9.0	11.7	500
055014311303	Blanc	3	-	14.9	18.5	9.0	-	500
1287225	Naturel	1	M16 X 1.5	15.0	18.7	7.0	9.0	1000
055015400003	Naturel	3	-	15.4	19.0	8.5	11.5	500
054154911303	Blanc	3	-	15.4	19.0	8.5	-	500
054154922003	Noir	3	-	15.4	19.0	8.5	-	500
12789	Naturel	1	M18 X 2.5, 3/8" BSP	15.6	20.0	8.0	10.0	5000
494375	Noir	1	M18 X 2.5, 3/8" BSP	15.6	20.0	8.0	10.0	500
055015700003	Naturel	3	-	15.9	19.0	8.5	10.8	500
055015722003	Noir	3	-	15.9	19.0	8.5	-	500
055015711303	Blanc	3	-	15.9	19.0	8.5	-	500
1287229	Naturel	2	M18 X 2, M18 X 1.5, M18 X 1	16.5	18.7	7.0	9.0	1000
055016800003	Naturel	3	-	17.0	19.5	9.0	11.6	500
055016822003	Noir	3	-	17.0	19.5	9.0	-	500
055016811303	Blanc	3	-	17.0	19.5	9.0	-	500
12790	Naturel	1	-	17.0	22.0	8.2	10.8	5000
494376	Noir	1	-	17.0	22.0	8.2	10.8	500
055017200003	Naturel	2	-	17.4	23.0	9.5	-	500
465687	Naturel	1	M20 X 2	17.8	24.6	9.0	11.3	1000
12791	Naturel	1	M20 X 2.5	18.4	25.0	8.0	10.5	5000
494377	Noir	1	M20 X 2.5	18.4	25.0	8.0	10.5	500
055018300003	Naturel	2	-	18.8	21.5	9.0	12.0	500
12792	Naturel	1	1/2" BSP	19.3	25.0	8.0	11.0	5000
494378	Noir	1	1/2" BSP	19.3	25.0	8.0	11.0	500
465688	Naturel	1	M22 X 2	19.5	24.6	9.0	11.1	1000
055019600003	Naturel	2	-	19.6	25.5	9.3	-	500
1255333	Naturel	1	M22 X 1.5	20.1	24.6	9.0	11.1	500
055020000003	Naturel	3	-	20.5	25.2	9.0	12.0	250
055020022003	Noir	3	-	20.5	25.2	9.0	12.0	500
055020011303	Blanc	3	-	20.5	25.2	9.0	-	500
12980	Naturel	1	M22 X 1.5	20.5	30.0	10.7	13.2	3000
055021000003	Naturel	2	-	21.0	25.6	12.6	15.6	250
055021022003	Noir	2	-	21.0	25.6	12.6	15.6	500
055021011303	Blanc	2	-	21.0	25.6	12.6	-	500
12793	Naturel	1	5/8" BSP	21.2	25.0	7.5	9.5	5000
12794	Naturel	1	-	21.7	25.0	8.0	10.5	4000
494379	Noir	1	-	21.7	25.0	8.0	10.5	500
12796	Naturel	1	M24 X 2	22.4	28.0	9.0	12.0	4000
494380	Noir	2	M24 X 2	22.4	28.0	9.0	12.0	500
055022300003	Naturel	3	-	22.6	29.0	9.0	-	500
055023000003	Naturel	1	-	23.0	27.4	19.3	20.8	100
12797	Naturel	1	-	23.4	28.0	9.0	12.0	4000
494381	Noir	1	-	23.4	28.0	9.0	12.0	500

BOUCHONS À PRESSION

Bouchon de protection *SUITE*

SR 1011

PEBD naturel / blanc / noir

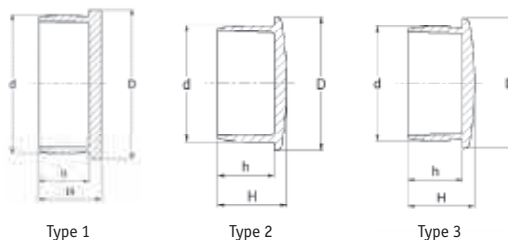

Référence	Couleur	Type	Pour filetage	Dimensions (mm)				Qté par sac
				d	D	h	H	
055024000003	Naturel	1	-	24.0	27.0	12.8	14.4	100
12799	Naturel	1	M26, 3/4" BSP	24.6	28.0	9.0	12.0	3000
494382	Noir	1	M26, 3/4" BSP	24.6	28.0	9.0	12.0	500
055025500003	Naturel	2	-	24.8	31.5	6.0	8.2	100
055024500003	Naturel	3	-	25.0	32.0	13.0	16.2	100
12800	Naturel	1	M27	25.5	28.0	7.5	9.5	3000
494383	Noir	1	M27	25.5	28.0	7.5	9.5	500
055026000003	Naturel	3	-	26.0	31.5	12.3	-	500
055026100003	Naturel	2	-	26.0	31.5	12.0	-	500
12801	Naturel	1	M28 X 1.5	26.5	28.0	9.0	12.0	4000
494384	Noir	1	M28 X 1.5	26.5	28.0	9.0	12.0	500
055027200003	Naturel	2	-	27.0	29.6	15.0	16.4	100
465690	Naturel	1	M30 X 3	27.5	34.8	12.0	14.5	500
055028600003	Naturel	3	-	28.6	34.0	15.0	18.8	100
12802	Naturel	1	-	29.0	36.0	12.0	15.0	3000
12803	Naturel	1	7/8" BSP	30.5	36.0	12.0	15.0	2500
494385	Noir	1	7/8" BSP	30.5	36.0	12.0	15.0	500
055031200003	Naturel	3	-	31.2	38.0	13.0	-	500
12804	Naturel	1	M33 X 1.5, 1" BSP	31.8	36.0	10.0	12.5	2000
1255334	Naturel	1	M33 X 2, M33 X 1.5, M36 X 3	32.6	34.8	12.0	14.5	500
055033500003	Naturel	3	-	33.5	41.0	12.0	14.8	100
12805	Naturel	1	M35 X 1.5	33.5	36.0	12.0	15.0	2000
494386	Noir	1	M35 X 1.5	33.5	36.0	12.0	15.0	500
055034000003	Naturel	1	-	34.0	40.0	20.0	-	500
110479	Naturel	1	-	34.8	42.0	15.0	18.0	2000
055035600003	Naturel	2	-	35.5	46.5	15.0	19.5	100
110480	Naturel	1	-	36.5	42.0	15.0	18.0	2000
055036500003	Naturel	3	-	36.5	46.5	18.0	-	500
465692	Naturel	1	M39 X 3	37.6	40.4	12.0	14.5	500
110481	Naturel	1	-	38.4	42.0	15.0	18.0	2000
1258454	Naturel	1	M39 X 1.5, M42 X 3	39.0	49.3	16.0	18.9	500
055039500003	Naturel	3	-	39.5	46.0	16.0	-	500
110482	Naturel	1	-	40.6	44.0	15.0	18.0	1500
055042000003	Naturel	3	-	42.2	44.5	13.0	-	500
10122	Naturel	1	-	42.3	48.0	15.0	18.0	1000
055043300003	Naturel	3	-	43.3	50.5	15.0	18.0	100
055044500003	Naturel	3	-	45.3	51.0	16.0	-	500
055045800003	Naturel	3	-	45.8	51.0	16.0	-	500
110483	Naturel	1	-	46.0	55.0	18.0	21.0	1500
055050500003	Naturel	3	-	50.5	57.0	14.0	19.4	100
110484	Naturel	1	1 3/4" BSP	51.5	55.0	18.0	21.0	1500
055052000003	Naturel	3	-	52.5	60.0	14.0	17.5	100
465694	Naturel	1	M56 X 4, M56 X 3, M56 X 2	54.1	58.7	18.0	21.0	500
055055300003	Naturel	1	-	55.3	59.5	19.5	23.0	100
055055500003	Naturel	3	-	55.5	59.0	16.0	-	500
055058000003	Naturel	3	-	58.0	63.0	19.5	-	500
110485	Naturel	1	2" BSP	58.0	64.0	18.0	21.0	750
465695	Naturel	1	-	59.6	73.5	18.0	21.0	500
055061500003	Naturel	3	-	61.0	74.0	19.0	-	250
12137	Naturel	1	M72 X 2	70.0	78.0	18.0	21.5	500
055070000003	Naturel	3	-	70.0	80.0	18.0	-	250
465696	Naturel	1	M75 X 1.5	73.7	82.3	17.4	20.4	250
1287227	Naturel	1	M80 X 4	80.8	92.5	17.4	20.4	250
055085000003	Naturel	1	-	85.0	93.5	18.0	19.7	50
465698	Naturel	1	M76 X 2	86.5	99.3	17.4	20.4	250
465699	Naturel	1	M100 X 2	98.8	112.0	17.4	20.4	250
055110000003	Naturel	2	-	110.5	130.0	18.0	21.5	50
465700	Naturel	1	M115 X 4	111.7	123.0	17.4	20.4	250

Flexiplugs

SR 1070

PVC flexible noir

- Idéal pour les orifices filetés ou lisses
- Bonne résistance aux fissures et à la fragmentation

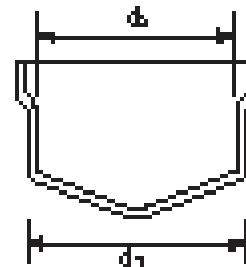

Référence	Dimensions (mm)		Pour filetage		Qté par sac
	d1	d2	UNF	métrique	
FPWA-072	7.2	4.4	5/16"	M8	5000
FPWA-091	9.1	6.4	3/8"	M10	5000
FPWA-103	10.3	7.5	7/16"	-	5000
FPWA-118	11.8	9.0	1/2"	M12	5000
FPWA-135	13.5	10.7	9/16"	M14	5000
FPWA-154	15.4	12.6	5/8"	M16	5000
FPWA-191	19.1	16.3	3/4"	M20	2000
FPWA-216	21.6	18.8	7/8"	M24	2500
FPWA-258	25.8	23.0	1 1/16"	M27	2500
FPWA-302	30.2	27.4	1 3/16"	M33	2500

DÉCOUPAGE PERSONNALISÉ DISPONIBLE POUR RÉPONDRE À VOS BESOINS

Essentra Components a pour objectif de travailler avec vous et répondre à vos besoins.

Nous développons des solutions de masquage pré-découpées et personnalisables, qui assurent une rapidité d'utilisation, de précision, réduisant ainsi le coût total du processus de masquage.

- Notre expertise à votre disposition
- Solutions sur-mesure
- Prototypes créés par notre imprimante
- 8 machines de découpe et 1 imprimante à plat

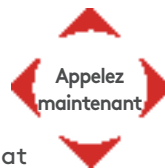

Veillez contacter votre représentant commercial pour de plus amples informations



BOUCHONS À PRESSION

Ezeplugs

SR 1055

Polyéthylène basse densité rouge

- Modèle déposé
- Pose facile par simple pression
- Pour une gamme de perçages filetés et lisses
- Six tailles couvrent plus de 29 tailles de filetages standards
- Languette solide et flexible, pour une dépose rapide



Type 1 : Languette latérale

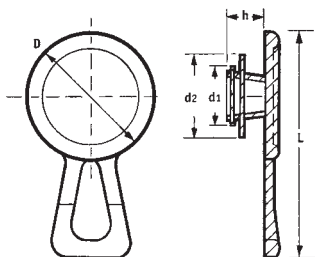

Type 1 : Languette latérale

Référence	Pour filetage			Dimensions (mm)					Qté par sac
	UNF	BSP	Métrique	h	D	d1	d2	L	
10093	7/16"	1/8"	M10, M12	9.0	19.0	9.0	13.2	34.0	5000
10094	1/2", 5/8", 9/16"	1/4"	M14, M16	7.0	22.7	12.0	16.5	40.0	5000
10095	3/4"	3/8"	M18, M20	8.0	30.0	15.5	19.5	47.0	4000
10096	7/8"	1/2", 5/8"	M22, M24	9.5	34.3	19.3	23.8	51.4	3000
10778	1 1/16", 1 1/8"	3/4"	M26, M28	9.5	40.0	22.5	27.6	57.0	2000
110001	1 1/4", 1 3/8"	1"	M30, M36	10.0	45.0	29.9	34.5	62.0	1500



Type 2 : Languette centrale

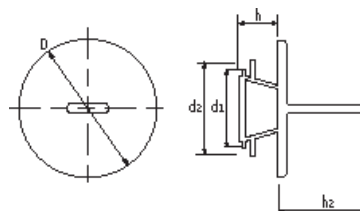

Type 2 : Languette centrale

Référence	Pour filetage			Dimensions (mm)					Qté par sac
	UNF	BSP	Métrique	h	D	d1	d2	h2	
467027	7/16"	1/8"	M10, M12	9.0	19.0	9.0	13.2	21.2	500
467028	1/2", 5/8", 9/16"	1/4"	M14, M16	7.0	22.7	12.0	16.5	21.2	500
467029	3/4"	3/8"	M18, M20	8.0	29.5	15.0	19.5	21.4	250
467030	7/8"	1/2", 5/8"	M22, M24	9.5	34.3	19.3	23.8	21.4	250
467031	1 1/16", 1 1/8"	3/4"	M26, M28	9.5	40.0	22.5	27.6	21.5	100
467032	1 1/4", 1 3/8"	1"	M30, M36	10.0	45.0	29.9	34.5	21.6	100

Bouchons à pression - Uniplugs

SR 1039

Polyéthylène basse densité rouge

- Modèle unique permettant une installation rapide et sécurisée dans les trous filetés

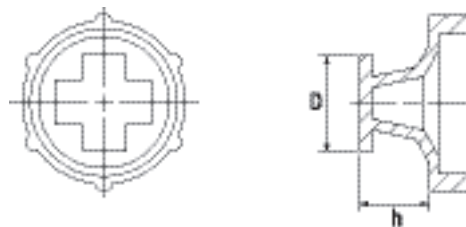

Référence	Pour filetage				Dimensions (mm)		Qté par sac
	NPT	UNF	BSP	Métrique	D	h	
10538	1/8"	7/16"	1/8"	M10	11.0	6.1	10000
15987	-	1/2"	1/4"	M12	12.3	8.3	10000
10537	1/4"	9/16"	-	M14	14.5	7.2	10000
10533	-	3/4"	1/2"	M20	19.7	9.5	5000
10532	-	1"	5/8" - 3/4"	M22-26	25.1	11.3	5000
10515	3/4"	1 3/16"	7/8"	M30	31.4	11.0	2000
10531	-	1 7/16"	1"	M33-36	37.7	12.5	2000

Bouchons à languette

SR 1069

Polyéthylène basse densité bleu

- Empêche l'intrusion de corps étrangers dans le tube
- Pose et dépose rapide
- Petite languette, faible encombrement
- Idéal pour tube de cuivre de faible épaisseur



Référence	Dimensions			Qté par sac
	d (pouces)	Pour tube de diamètre (mm)	h (mm)	
110771	3/8	9.5	9.0	5000
110772	1/2	12.7	12.2	5000
110773	5/8	15.9	15.2	5000
110774	3/4	19.0	18.5	2500
110775	7/8	22.2	21.7	2500
110776	1 1/8	28.6	28.0	2500

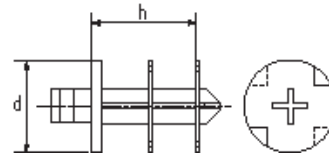

Bouchons de protection pour taraudages

SR 1034

PVC noir

- Tige conique et corps creux
- Chaque modèle s'adapte à plusieurs tailles de trous filetés

Référence	Dimensions (mm)				Qté par sac
	d ₁	d ₂	h	d ₃	
10510†*	3.2	1.5	15.0	-	10000
10398†*	5.0	3.0	15.0	-	10000
18409†*	6.0	4.0	25.0	-	6000
11132	8.0	6.0	25.0	2.5	6000
11133	10.0	8.0	25.0	4.0	4000
11134	12.0	10.0	25.0	6.0	4000
11135	14.0	12.0	25.0	8.0	3000
11136	16.0	14.0	25.0	10.0	2000
11137	18.0	16.5	25.0	12.0	2000

† Caoutchouc thermoplastique

* Corps lisses

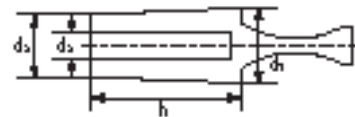

Bouchons à collerette

SR 1160

Polyéthylène basse densité orange

- Auto-taraudeur
- Plus résistant du fait de l'épaisseur de la paroi



Référence	Taille	Dimensions (mm)					Qté par sac
		D	d	d ₁	H	h	
464111	M2	8.0	2.0	1.3	14.5	7.5	5000
464112	M3	8.0	3.0	2.2	20.0	12.0	5000
464113	M4	8.0	3.9	2.9	22.5	15.0	2500
464114	M5	9.0	5.0	3.7	27.5	17.5	2500
464115	M6	10.0	5.8	4.4	27.5	17.5	2500
464116	M7	11.0	6.5	5.2	27.5	17.5	2500
464117	M8	14.0	7.5	6.2	27.5	17.5	2000
464118	M9	14.0	8.5	6.8	27.5	17.5	2000
464119	M10	16.0	9.5	7.6	30.5	20.5	1500
464120	M12	18.0	11.0	9.6	30.5	20.5	1500

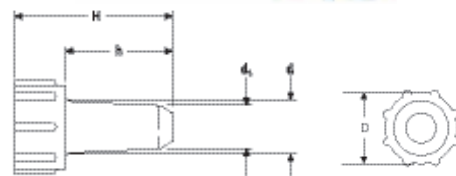

BOUCHONS À PRESSION

Bouchons Moss à languette

SR 1067

Caoutchouc thermoplastique noir

- Pour la protection des orifices de composants filetés ou lisses
- Languette facilitant le retrait
- Résistent aux acides
- Supportent des températures comprises entre -40°C et +135°C
- Recommandés pour des applications hydrauliques et en construction mécanique

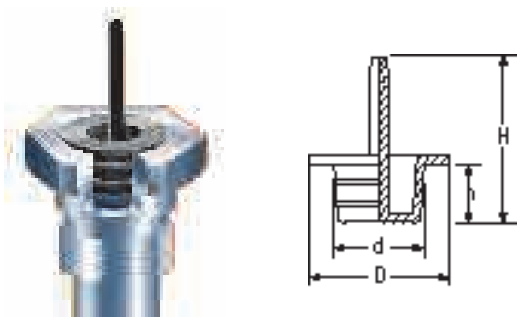

Type 1 - Bouchon languette centrale

Référence	Taille de filetage	Dimensions (mm)				Qté par sac
		d	D	h	H	
464905	M8	7.5	15.5	8.0	24.0	500
110043	M10	9.5	17.5	8.0	30.0	8000
110044	M12	11.5	19.5	8.0	30.0	7000
110045	M14	12.8	21.5	10.0	30.0	6000
110046	M16	15.2	23.5	10.0	32.0	4000
464906	M18	17.6	25.5	10.0	26.0	500
464907	M20	19.4	27.5	12.0	26.0	500
464908	M22	21.4	29.5	12.0	26.0	250
464909	M24	23.5	28.5	12.0	26.0	250



Type 2 - Bouchon languette latérale

Référence	Taille de filetage	Dimensions (mm)				Qté par sac
		d	D	h	L	
464857	M6	5.5	15.5	8.0	23.2	500
110291	M8	7.5	15.0	8.0	25.3	7000
110280	M10	9.5	17.0	8.0	27.3	7000
110281	M12	11.5	17.0	8.0	27.5	7000
110282	M14	13.0	21.0	10.0	31.0	6000
110283	M16	15.5	23.0	10.0	33.3	4000
110294	M18	17.0	26.0	10.0	35.5	4000
464858	M20	19.4	27.5	12.0	37.1	500
464859	M22	21.4	29.5	12.0	39.4	250
464860	M24	23.5	28.5	12.0	40.8	250

Bouchons à pression

SR 1008

Polyéthylène basse densité rouge

- Après une simple pression, un seul tour assure une fixation serrée

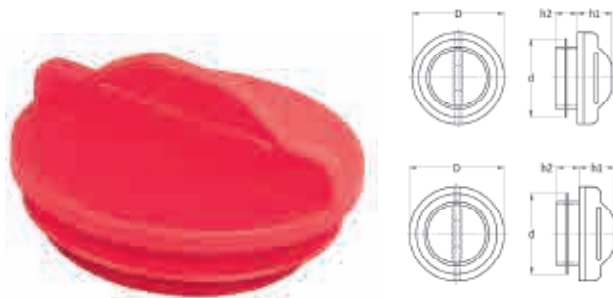

Référence	Pour filetage			Dimensions (mm)				Qté par sac
	Métrique	BSP/GAZ	UNF/JIC	d	D	h1	h2	
10530	M10	1/8"	7/16"	9.8	-	6.0	4.0	12000
12363	M12, M13, M14	1/4"	1/2"	13.1	15.8	12.0	5.0	10000
12364	M16	3/8"	5/8"	16.5	19.5	14.0	5.0	10000
10314	M18	-	3/4"	18.3	21.5	11.5	7.0	7000
12365	M20	1/2"	-	21.3	22.7	12.0	7.0	5000
12366	M22	5/8"	7/8"	22.4	25.8	12.0	7.0	5000
12621	M24	-	-	23.5	28.2	12.0	7.0	3000
12367	M25, M26	3/4"	1 1/16"	25.5	29.9	12.0	7.0	2000
12368	M28	7/8"	1 1/8"	27.9	32.7	12.0	7.0	3000
12369	M32	1"	1 5/16"	32.0	35.6	12.0	7.0	2500
12622	M36	1 1/8"	1 1/2", 1 3/8"	35.7	39.7	12.0	7.0	2000
12598*	M40, M42	1 1/4"	1 5/8"	41.5	45.4	7.0	7.0	2000

* Languette différente

Bouchons**SR 1010****Polyéthylène basse densité**

- Facile à poser
- Convient à la plupart des applications

Bleu UNF/JIC

Référence	Taraudage	Dimensions (mm)			Qté par sac
		D	h	d	
12512	7/16" x 20	15.5	7.0	9.5	10000
12513	1/2" x 20	17.0	7.0	11.0	10000
12514	9/16" x 18	20.5	7.0	12.5	10000
12515	5/8" x 18	23.7	6.5	14.3	10000
12516	3/4" x 16	24.9	8.6	17.4	8000
12517	7/8" x 14	26.6	10.4	20.3	5000
12518	1" x 14	31.0	10.0	23.5	4000
12519	1 1/16" x 12	35.5	10.0	24.8	2000

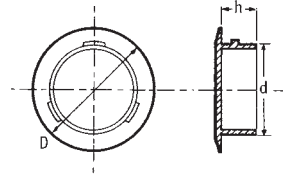
**Rouge sans ergots**

Référence	Dimensions (mm)			Qté par sac
	D	h	d	
12520	16.4	6.3	11.9	5000
12522	23.8	7.0	19.2	5000
12523	30.0	6.1	25.5	2500
12524	35.0	8.0	30.9	2000

Bouchons filetés à pose facile**SR 1119****Polyéthylène basse densité jaune**

- Tous les avantages d'un bouchon fileté avec une pose facile

Référence	Taraudage UNF	Dimensions (mm)		Qté par sac
		D	h	
I-1/4	1/4"	5.2	5.6	5000
I-5/16	5/16"	6.7	6.0	5000
I-3/8	3/8"	8.2	6.0	3000
I-7/16	7/16"	9.7	6.9	3000
I-1/2	1/2"	11.1	6.9	5000
I-9/16	9/16"	12.6	7.4	5000
I-5/8	5/8"	14.2	7.4	7500
I-11/16	11/16"	15.5	7.4	7000
I-3/4	3/4"	17.2	7.4	6000
I-13/16	13/16"	18.6	7.4	5000
I-7/8	7/8"	20.3	7.4	4500
I-1	1"	23.4	7.4	3500
I-1-1/16	1 1/16"	24.7	7.4	3000
I-1-3/16	1 3/16"	27.7	8.6	2000
I-1-1/4	1 1/4"	29.5	8.6	2000
I-1-5/16	1 5/16"	30.9	8.6	2000
I-1-5/8	1 5/8"	38.7	11.7	1000
I-1-7/8	1 7/8"	45.1	11.7	800

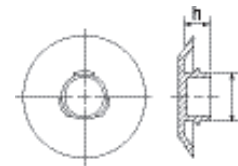
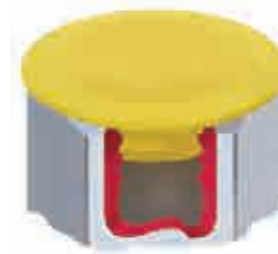
**Petits récipients à couvercles****SR 1651****Polyéthylène basse densité transparent**

- Couvercles à emboîter
- Idéal pour pillules, épingles, petites pièces et les pâtes

Référence		Capacité nominale (ml)	Dimensions intérieures (mm)		Qté par sac
Base	Couvercle		Diamètre	Hauteur	
10514	10513	2.0	21.0	6.4	3000
1293853	1293855	10.0	33.3	10.7	3000
1295114	1295112	17.5	42.0	13.0	1500
1316297	1295113	30.0	51.5	14.5	1000
1316295	1295115	40.0	38.5	35.6	1500
1316296	1295113	100.0	50.8	51.0	500



BOUCHONS À PRESSION

Capés/Bouchons GPL

SR 1085

Polyéthylène basse densité

- Développé en collaboration avec des industries GPL
- Permet d'éviter les fuites de gaz dangereuses
- Conforme au code de bonnes pratiques de l'association GPL (15:2)
- Bride de sécurité pour éviter de perdre la cape ou le bouchon et pour faciliter sa remise en place
- Marquage, consignes d'utilisation de pose/dépose indiquées

Tests de pression

Propane/mélanges (types 1 & 2) 26 bars

Butane (type 3) 26 bars

Testés indépendamment pour supporter ces pressions, tout en assurant une étanchéité, même à hautes températures et dans les conditions les plus difficiles (certificat et résultats des tests disponibles sur demande)

Matière Type 1: Bouchon: PEHD, Languette: PEBD. Type 2: Cape: PEHD. Type 3: Cape: PEHD, Languette: PEBD



Type1



Type2



Type 3

Référence	Type	Pour raccord *	** Type de valve	Description de valve	Type Gaz	Qté par sac
110471	1	105	-	P.O.L 5/8" BSP - LHT	Propane	1000
467140	2	109	A	W21.8 x 1/4 LHT	Divers	250
110256	3	403	-	20mm 'Quick-On'	Butane	1000
110257	3	402	-	21mm 'Quick-On'	Butane	1000

* Selon code de bonnes pratiques de l'association GPL (15: article 2)

** Selon DIN 477 Partie 1

ESSAYEZ AVANT
D'ACHETER - DEMANDEZ
VOS ÉCHANTILLONS
GRATUITS DÈS
AUJOURD'HUI

Pour toute commande appelez
au 01 48 17 50 00
ou consultez www.essentracomponents.fr

Bouchons protecteurs pour robinets de bouteilles de gaz

SR 1060

Polyéthylène basse densité jaune

- Développé conjointement avec des grandes entreprises européennes de fourniture de gaz
- Permet de détecter toute manipulation non autorisée
- Protège les bouteilles de gaz industriel contre la pénétration de la poussière et des débris
- Event de sécurité en cas d'ouverture accidentelle de la bouteille de gaz

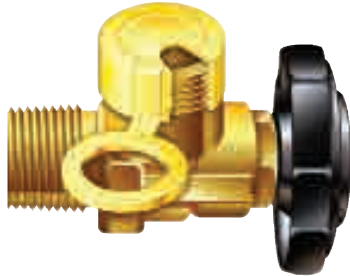

Type 1



Type 2



Type 3



Type 4



Type 5



Type 6

Référence		Diamètre nominal (mm)	Type	Pour taille de valves BS †	Type Gaz	Qté par sac
standard	Avec évént					
12940	110048*	21.7	1	-	-	2000
10781	110009	21.8	1	8	CO2	2000
110007	110008	24.3	1	-	-	2000
10783	-	25.4	1	-	-	2000
110005	110006	26.4	1	-	-	2000
10784	-	28.8	1	-	-	2000
10785	110004	22.2	2	2, 3, 4	N2, O2, H2, He, C2H2, Ar	2500
10787	-	25.0	3	-	Médical	2000
110049	-	20.0	4	-	-	500
110583	-	30.0	4	-	-	500
110239	110240	30.0	5	** Nevoc	-	1000
-	110586	35.0	5	-	-	1000
-	110588	38.0	5	-	-	1000
110589	-	21.8	6	8	CO2	500
110590	-	24.3	6	-	-	500
110832	-	28.0	6	-	-	500
110592	-	30.0	6	** Nevoc	-	500

* Fourni avec bande évént. ** Spécialement conçu pour robinets N.E.V.O.C. † Selon la norme BS 341 avec sorties whitworth 30mm de plus en plus fréquemment utilisées sur les bouteilles 300-bars. Autres couleurs disponibles; pour tous renseignements complémentaires, veuillez contacter notre bureau commercial

Bouchon conique à languette latérale

SR 1053

Caoutchouc thermoplastique naturel

- Matière souple permettant un montage serré
- La languette latérale facilite le retrait
- Adapté à de multiples applications

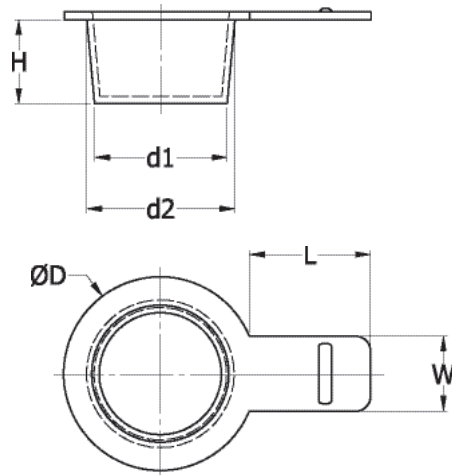

Référence	Dimensions (mm)						Qté par sac
	d1	d2	D	H	W	L	
494297	5.0	7.0	11.0	9.5	7.0	15.0	5000
494298	6.0	8.0	12.0	9.5	7.0	15.0	5000
494299	7.0	9.5	13.5	9.5	7.0	15.0	5000
494300	8.0	10.0	14.0	9.5	8.0	15.0	5000
494301	9.5	11.5	15.5	9.5	8.0	15.0	5000
494302	10.5	12.5	16.5	9.5	8.0	15.0	5000
494303	11.5	13.5	17.5	9.5	8.0	15.0	5000
494304	12.5	14.5	18.5	10.0	8.0	15.0	5000
494305	13.5	15.5	19.5	10.0	10.0	15.0	5000
494306	14.2	16.2	20.2	10.0	10.0	15.0	5000
494307	14.5	17.0	21.0	10.0	10.0	15.0	2000
494308	15.5	18.0	22.0	10.0	10.0	15.0	2000
494309	17.5	19.5	23.5	10.0	10.0	15.0	2000
494310	19.0	21.5	25.5	11.0	10.0	15.0	2000
494311	21.0	23.5	27.5	11.0	10.0	15.0	2000
494312	22.5	25.5	29.5	12.0	12.0	15.0	2000
494313	25.0	28.0	32.0	12.0	12.0	15.0	2000
494314	29.0	31.5	35.5	12.0	12.0	15.0	2000

ENCORE PLUS SIMPLE!

- ▶ Simple de commander en ligne
- ▶ Simple de demander des échantillons gratuits
- ▶ Produits faciles à trouver
- ▶ Téléchargement facile des fichiers 3D CAO



www.essentracomponents.fr

Bouchons pour extrémités de tubes

SR 1601

Polyéthylène basse densité blanc

- Pour une obturation sûre des tubes postaux, des tubes en matériaux composites et des tubes en plastique transparent

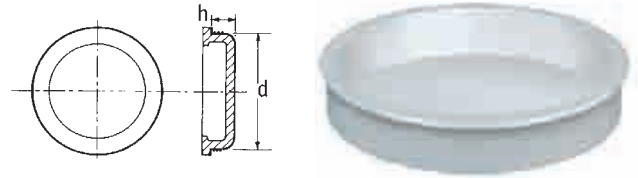

Gamme peu profonde

Référence	Dimensions (int)		Qté par sac
	d	h	
12360	1.25	0.25	3000
12361	1.37	0.25	3000
12362	1.62	0.25	2000
11926	2.0	0.25	1200
11927	2.25	0.25	2000
11928	2.5	0.25	2000
11930	3.0	0.25	500

Gamme métrique

Référence	Dimensions (mm)		Qté par sac
	d	h	
11619	25.0	8.0	12500
11587	30.0	8.4	8000
12641	40.0	7.8	5000
12305#*	46.0	10.5	3000
12642	50.0	6.9	3000
10920	54.0	8.0	2500
12643	60.0	7.0	2000
12306#	63.0	10.5	1200
12644	71.5	8.0	1800
12307	78.4	10.8	800
12645	80.0	10.2	1000
10724	99.0	8.8	700
12646	100.0	10.8	500
12974	108.0	10.7	500
12964	150.0	12.2	200

A languette

* Avec trou d'évent en option

Gamme anglo-saxonne

Référence	Dimensions (int)		Qté par sac
	d	h	
11123	1.5	0.375	2000
10290	1.75	0.375	1200
15141*	2.0	0.45	3000
10148	2.25	0.375	2000
15142*	2.5	0.45	2000
12300	2.56	0.375	1500
10291	2.75	0.437	1500
1330786*	3.0	0.43	1000
11357	3.25	0.50	800
12730	3.3	0.375	800
11358	3.5	0.50	700
11600	3.75	0.50	700
10138	4.0	0.50	600
11888	4.5	0.50	500
12304	4.75	0.50	400
11450	5.0	0.60	300
11898	5.5	0.50	300
11572	6.0	0.59	150
11974	6.5	0.50	200
51854	8.0	0.50	100

* Incorpore une entrée biseautée pour faciliter l'insertion

Bouchons pour extrémités de tubes avec languette circulaire

SR 1603

Polyéthylène basse densité blanc

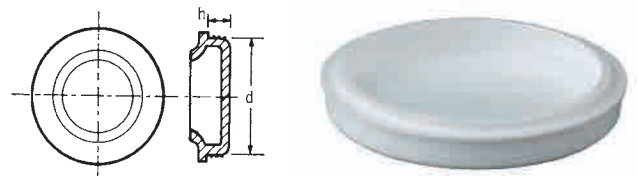

Gamme anglo-saxonne

Référence	Dimensions (int)		Qté par sac
	d	h	
12580	2.0	0.38	2000
12624	2.25	0.38	2000
10301	2.5	0.32	1500
12561	3.0	0.35	1000
12626	3.5	0.5	700
12627	4.0	0.32	600
12628	5.03	0.6	250
12629	6.0	0.5	150

Gamme métrique

Référence	Dimensions (mm)		Qté par sac
	d	h	
12580	50.0	9.5	2000
12581	60.0	9.5	1800
12582	66.0	7.5	750
10725	71.0	6.0	1000
12560	70.0	9.5	1000
12584	95.0	7.5	600

BOUCHONS À PRESSION

Bouchons pour extrémités de tubes - avec prise pour les doigts

SR 1604

Polyéthylène basse densité blanc ou rouge

- Prise pour les doigts en option pour dépose facile



Avec prise pour les doigts

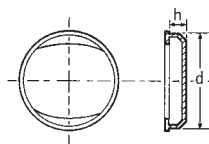

Sans prise pour les doigts

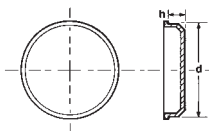

Référence			Dimensions (mm)		Qté par sac
Avec prise pour les doigts		Sans prise pour les doigts	d	h	
Blanc	Rouge	-			
10254	10422	-	30.0	7.8	10000
199500	199104	10228	40.0	10.8	4000
199501	199126	10242	50.0	10.8	2500
199502	199128	10245	60.0	10.7	1750
199503	199175	10246	70.0	10.5	1000
199504	199060	10247	80.0	12.5	800
199505	199152	-	90.0	12.5	600
199506	199166	10248	100.0	12.5	500
10542	50126	-	110.0	12.8	350
199507	199508	-	120.0	12.2	300
10543	50192	-	125.0	13.0	300
10544	50194	-	135.0	13.3	200

Capés pour goujons

SR 1024/25/1124

Polyéthylène basse densité

- Utilisé dans l'industrie automobile et en construction mécanique pour protéger les goujons exposés.

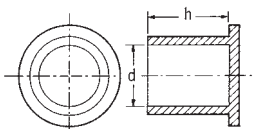

SR 1124 Polyéthylène basse densité transparent gamme anglo-saxonne

Référence	Filetage UNF	Dimensions (mm)			Qté par sac
		D	d	h	
E-3/8-A	3/8"	14.7	9.6	15.7	5000
E-1/2	1/2"	18.2	12.5	11.7	4000
E-9/16	9/16"	20.5	14.0	12.5	5900
E-3/4-CAT	3/4"	25.5	18.5	15.9	3000
E-13/16	13/16"	26.9	20.3	14.5	2500
E-7/8-CAT	7/8"	27.8	22.0	21.1	3500
E-1	1"	31.6	25.0	16.8	1500
E-1-3/16	13/16"	36.3	29.8	19.3	2000
E-2-1/2	2 1/2"	70.0	63.3	30.7	350

SR 1025 Polyéthylène basse densité rouge gamme anglo-saxonne

Référence	Dimensions			Qté par sac
	d (pouces)	d (mm)	h (mm)	
11098*	-	4.4	12.7	5000
51534*	1/4	6.4	41.3	7000
50454	5/16	7.9	19.1	10000
60273	-	7.5	38.1	5000
10660	-	9.1	27.2	7000
11906	7/16	11.1	23.8	6000
51051	-	11.9	22.2	5000
10618	-	11.9	28.6	4000
11160	-	12.7	27.3	4000
10243	1/2	12.7	46.0	2500
11162	-	14.0	21.0	5000
10723	9/16	14.3	33.6	1500
10720	5/8	15.9	23.8	3000
60864	5/8	15.9	71.8	1000
10691	3/4	19.0	33.6	2000
10191	13/16	20.6	36.5	1200
10426	7/8	22.2	77.8	500
10959	-	23.5	55.5	600
11270	1	25.4	62.8	500
11292	1 1/8	28.6	62.8	400
11319	1 1/4	32.0	58.5	1000
60807	1 1/2	38.1	44.5	400

*PVC Noir

SR 1024 Polyéthylène basse densité transparent

Gamme métrique (avec tête crantée)

Référence	Dimensions (mm)		Qté par sac
	d	h	
12754	5.0	13.0	10000
12756	6.0	10.0	10000
12757	8.0	10.0	10000
12758	8.0	16.0	10000
12760	12.0	16.0	8000
10719	12.8	20.2	8000
12763	14.0	20.0	5000
12765	16.0	15.0	5000
12766	16.0	20.0	3000
12769	20.0	15.0	3000
12770	20.0	20.0	2000
12771	22.0	18.0	2000
12772	24.0	18.0	2000

Cape de protection goujon à mini collerette

SR1380

PEBD naturel

- Utilisé pour protéger le filetage BSP / UNF
- La petite collerette permet une pose facile avec une clé à douille



BSP

Référence	Taille filetage	Dimensions (mm)				Qté par sac
		d	D	h ₁	h	
110855	3/4" x 14	26.0	29.0	1.2	19.5	2000
110853	3/8" x 19	16.3	19.3	1.0	12.0	2000
110857	1/4" x 19	12.8	15.8	1.0	10.0	2000

UNF

Référence	Taille filetage	Dimensions (mm)				Qté par sac
		d	D	h ₁	h	
110856	9/16" x 18	13.8	16.8	1.0	12.0	2000
110859	11/16" x 16	17.0	20.0	1.0	13.0	2000
110854	3/4" x 16	18.6	21.6	1.2	15.0	2000
110858	13/16" x 16	20.2	23.2	1.2	15.0	2000

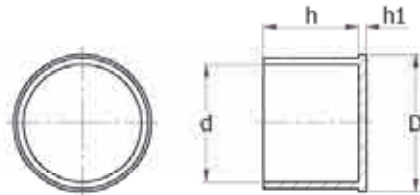

Capés de protection à collerette

SR 1116

Polyéthylène basse densité transparent

- Conçus pour protéger des filetages BSP / NPT et Métrique avec ou sans joints toriques

Impérial

Référence	Filetage BSP / NPT	Dimensions (mm)			Qté par sac
		D	d ₁	h	
ECS-0125	1/8"	16.8	10.1	9.7	10000
ECS-0250	1/4"	20.6	13.5	13.5	9000
ECS-0375	3/8"	23.9	17.0	13.5	5000
ECS-0500	1/2"	27.7	21.2	18.3	3000
ECS-0750	3/4"	33.3	26.5	19.1	2000
ECS-1000	1"	39.6	33.3	23.6	1000
ECS-1250	1 1/4"	49.3	42.0	24.6	800
ECS-1500	1 1/2"	54.9	48.1	24.6	600
ECS-2000	2"	66.6	60.2	26.2	500



Métrique

Référence	Pour filetage métrique	Dimensions (mm)			Qté par sac
		D	d ₁	h	
ECM-10	M10	13.5	9.8	16.9	8000
ECM-12	M12	19.5	11.8	12.0	7000
ECM-14	M14	21.5	13.7	12.0	5000
ECM-16	M16	23.5	15.7	12.0	5000
ECM-18	M18	25.5	17.7	12.0	3000
ECM-20	M20	27.5	19.7	14.1	2500
ECM-22	M22	29.5	21.7	14.1	3000
ECM-33	M33	40.4	32.6	17.5	2000
ECM-38	M38	44.5	37.6	19.0	1000

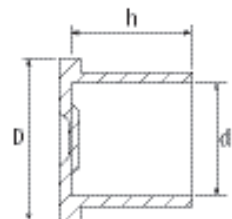

Capés de protection non-filetées

SR 1062

Polyéthylène basse densité bleu

- Disponible dans une grande variété de tailles
- Protection idéale des tuyaux filetés ou non filetés et tiges

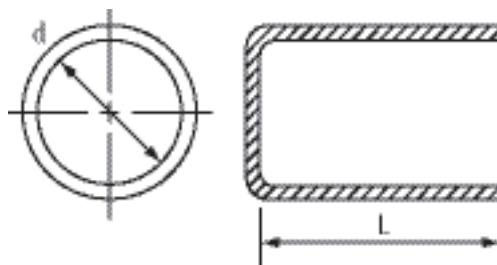
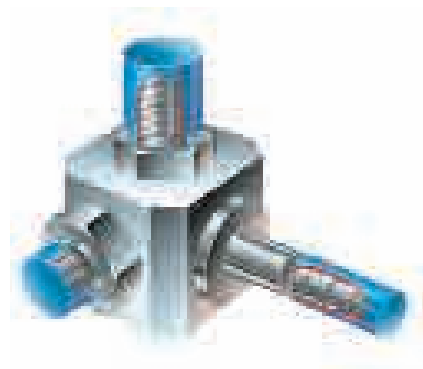

Référence	Dimensions				Qté par sac
	d		L		
	(pouces)	(mm)	(pouces)	(mm)	
A3/32W/RA	3/32	2.4	19/32	15.9	5000
A1/8W/RA	1/8	3.2	19/32	15.9	5000
110549	5/32	3.9	5/8	15.8	45000
110550	3/16	4.7	5/8	15.8	35000
110551	1/4	6.3	7/8	22.2	5000
L1/4A	1/4	6.4	1.3/4	44.5	7500
AS9/32A	9/32	7.1	1/2	12.7	6500
A9/32A	9/32	7.1	7/8	22.2	6500
AC5/16W/RA	5/16	7.5	7/8	22.2	6000
110552	5/16	7.9	7/8	22.2	10000
L5/16A	5/16	8.0	1.3/4	44.5	4500
110553	3/8	9.5	7/8	22.2	8500
L3/8A	3/8	9.5	1.3/4	44.5	3800
AS7/16A	7/16	11.1	1/2	12.7	6000
110554	7/16	11.1	7/8	22.2	7000
A1/2BA	1/2	11.9	7/8	22.2	5000
AS1/2A	1/2	12.7	1/2	12.7	5000
110555	1/2	12.7	7/8	22.2	5000
110556	9/16	14.2	7/8	22.2	4000
AS9/16A	9/16	14.3	9/16	14.3	6500
A9/16A	9/16	14.3	7/8	22.2	4000
110557	5/8	15.8	7/8	22.2	3500
AS5/8A	5/8	15.9	3/8	9.5	4250
110558	11/16	17.4	7/8	22.2	3000
AS11/16W/RA	11/16	17.5	3/4	19.5	4000
A23/32A	23/32	18.3		33.3	1700
K505A	23/32	18.3	1.1/2	38.1	2800
110559	3/4	19.0	7/8	22.2	5000
AS3/4A	3/4	19.1	3/8	9.5	6000
110560	13/16	20.6	7/8	22.2	4500
AS13/16W/RA	13/16	20.7	11/32	8.7	6000
AS7/8W/RA	7/8	22.2	1/2	12.7	3500
110561	7/8	22.2	7/8	22.2	4000
L7/8A	7/8	22.2	1.3/4	44.5	2000
110562	15/16	23.8	13/16	20.6	3500

Référence	Dimensions				Qté par sac
	d		L		
	(pouces)	(mm)	(pouces)	(mm)	
A63/64A	63/64	24.9		33.3	2000
110563	1	25.4	3/4	19.0	3500
AL1A	1	25.4	1	25.4	2500
L1B	1	25.4	1.3/4	44.5	1400
110564	1 1/16	26.9	7/8	22.2	3000
110565	1 1/8	28.5	7/8	22.2	2500
110566	1 3/16	30.1	1	25.4	2000
110567	1 1/4	31.7	7/8	22.2	2000
AS1-1/4A	1 1/4	31.8	19/32	15.9	3000
110568	1 5/16	33.3	7/8	22.2	2000
110569	1 3/8	34.9	7/8	22.2	1800
110570	1 7/16	36.5	7/8	22.2	1600
110571	1 1/2	38.1	7/8	22.2	1500
110572	1 9/16	39.6	1	25.4	1200
110573	1 5/8	41.2	1	25.4	1900
110574	1 11/16	42.8	7/8	22.2	1200
110575	1 3/4	44.4	7/8	22.2	1200
110576	1 7/8	47.6	7/8	22.2	1000
110577	2	50.8	7/8	22.2	1000
A2-1/8A	2 1/8	54.0	7/8	22.2	900
A2-1/4A	2 1/4	57.1	1.1/4	31.7	450
A2-3/8A	2 3/8	60.3	7/8	22.2	700
110578	2 1/2	63.5	7/8	22.2	600
AS2-9/16A	2.9/16	65.1	3/8	9.5	1200
A2-19/32W/RA	2.19/32	65.4	1	25.4	500
A2-5/8A	2.5/8	66.4	1	25.4	425
A2-3/4A	2.3/4	69.2		27.7	450
A3A	3	75.7	1	25.4	400
A3-1/8A	3.1/8	79.4		34.9	250
A3-1/4A	3.1/4	82.6		47.6	150
A3-1/2A	3.1/2	88.9	1	25.4	300
A3-3/4A	3.3/4	95.0	1	25.4	225
A4A	4	101.3	1	25.4	200
A4-1/8A	4.1/8	104.5	1	25.4	200

Bouchons pour extrémités de tube carton/plastique

SR 1610

Polyéthylène basse densité rouge

- Système de fermeture multi-usages
- Disponible dans une grande variété de tailles

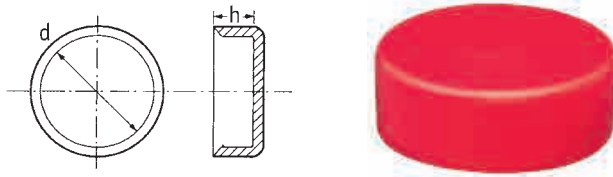

Référence	Dimensions (mm)		Qté par sac
	d	h	
15504*	8.9	8.0	5000
11418	19.0	13.0	5000
11308	22.1	11.0	5000
10888	25.5	13.1	3000
10541	28.5	13.3	2000
10192	31.7	12.8	2000
10389	34.7	12.5	1500
10594	38.0	12.2	1500
10297	41.2	12.8	1200
10152	44.5	12.4	1200
10918	47.0	12.4	1000
11130	50.3	11.7	1000
10539	53.5	12.3	2000
10402	57.0	12.5	700
10557	59.5	12.5	600
10711	63.0	12.6	500
12891	66.4	11.0	1200
10856	69.8	12.1	1500
12310	72.5	12.6	1000
10217	75.5	12.3	1000
11095	79.4	12.7	1000
11045	82.0	12.3	800
12308	85.0	12.2	800

* Existe en PVC noir

Capés à anneaux

SR 1046

Polyéthylène basse densité rouge

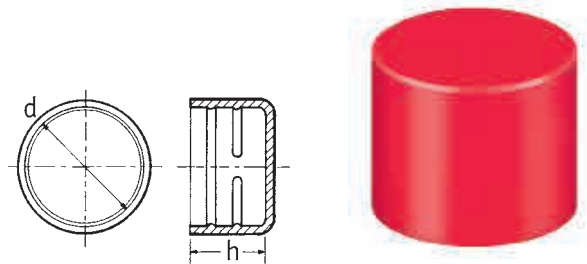

Référence	Dimensions (mm)		Qté par sac
	d	h	
12773	10.2	16.0	10000
12774	12.0	16.0	10000
12775	15.0	20.0	5000
12776	16.0	20.0	5000
12849	18.0	20.0	2500
12777	20.0	20.0	2000
12850	22.0	20.0	2500
12779	25.0	20.0	2000
12780	28.0	26.5	1000
12846	30.0	26.5	800
12781	35.0	26.5	800
12782	38.0	26.0	500
12982	54.0	27.8	300
12960*	110.0	34.6	150

* Cette référence est fournie en polyéthylène basse densité jaune

Bouchons longs pour extrémités de tube carton/plastique

SR 1620

Polyéthylène basse densité rouge

- Cape profonde pour tube. Bords en biseau pour une parfaite tenue
- Spécialement conçu pour ne pas être expulsé accidentellement



Référence	Dimensions (mm)		Qté par sac
	d	h	
12549	25.0	37.0	1000
12551	31.0	39.0	2000
12532	43.0	39.5	800
12554	57.0	44.0	700
12556	70.0	47.0	400
12558	81.5	54.0	250

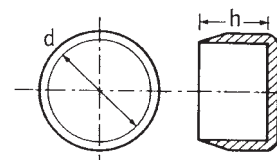

Capés pour graisseurs

SR 1019

Polyéthylène basse densité rouge

- Pour une protection efficace et peu coûteuse des graisseurs

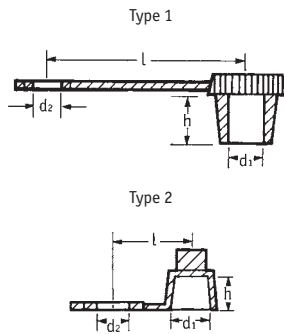

Référence	Type	Dimensions (mm)				Qté par sac
		d1	d2	l	h	
087063000503	1	6.0	6.4	29.5	9.3	250
61454	2	6.3	6.2	11.6	5.2	10000

Capés pour tuyaux

SR 1340

PVC gris

- Idéal pour les panneaux de signalisation
- Le PVC souple ne se cisaille pas, c'est une protection efficace contre la corrosion
- Le PVC souple permet une pose facile

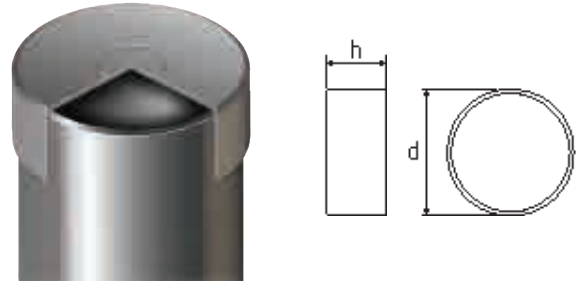

Référence	Dimensions (mm)		Taille nominale de tuyau	Qté par sac
	d	h		
462819	76.1	37.0	2 1/2"	250
462820	88.9	37.0	3"	200
462821	114.3	42.0	4"	125
462822	139.7	44.0	5"	80
462823	168.3	34.0	6"	75

Capés multi-flex

SR 1072

PVC noir flexible

- Se monte et se démonte facilement
- Un modèle unique qui s'adapte à plusieurs diamètres
- Pour la protection d'applications filetées ou lisses

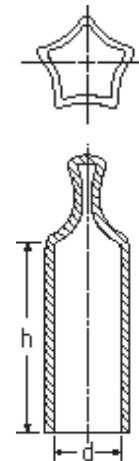

Référence	Pour filetage			Dimensions (mm)		Qté par sac
	métrique	UNF	BSP	d	h	
MFWA-090-025	M10	3/8"	1/8"	9.0-11.0	25.0	5000
MFWA-110-025	M12	7/16", 1/2"	1/4"	11.0-13.5	25.0	2000
MFWA-135-030	M14, M16	9/16", 5/8"	-	13.5-16.5	30.0	2000
MFWA-165-040	M18	3/4"	3/8"	16.5-20.0	40.0	1500
MFWA-200-050	M20, M22, M24	7/8"	1/2", 5/8"	20.0-24.0	50.0	1500

Capés à ailettes

SR 1056

Polyéthylène basse densité transparent

- Ce modèle unique à ailettes permet à chaque cape de s'adapter sur des goujons de diamètres différents

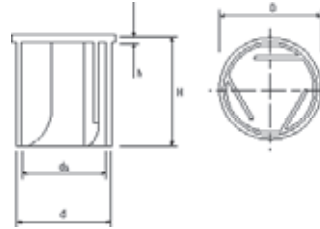

Type 1



Type 1: Avec prise

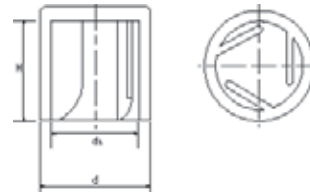

Type 2



Type 2: Sans prise

Référence	Type	Gamme de taille de goujon (mm)	Dimensions (mm)					Qté par sac
			d1	d	D	h	H	
466964	1	6.5-8.0	10.0	12.0	14.0	1.5	22.0	500
466965	1	8.0-9.0	11.0	13.0	15.0	1.5	22.0	500
466966	1	9.0-10.5	12.5	14.5	16.5	1.5	22.0	250
466967	1	11.0-13.0	16.0	18.0	20.0	1.5	22.0	250
466968	1	14.0-16.0	18.0	20.0	22.0	1.5	22.0	250
466969	1	17.0-19.0	22.0	24.0	26.0	1.5	22.0	100
466970	1	20.0-22.0	25.0	27.0	29.0	1.5	25.0	100
466971	1	24.0-26.0	29.0	31.0	33.0	1.5	30.0	100
466972	1	28.0-30.0	33.0	35.0	37.0	1.5	34.0	100
10220*	2	6.5-8.0	10.0	12.0	-	-	31.5	5000
10221	2	8.0-9.02	11.0	13.0	-	-	20.5	5000
10223	2	9.0-10.0	12.0	14.0	-	-	20.5	5000

* Cette taille a des coins biseautés.

Cape à pose et dépose rapide

SR 1022

- Pose et dépose rapide
- Langnette d'utilisation facile pour démontage rapide

Métrique

Polyéthylène basse densité jaune

Référence	Taille de filetage	Dimensions (mm)		Qté par sac
		h	d	
10839	M12	12.0	12.0	5000
10840	M14	14.1	14.0	5000
10080*	M16	16.5	16.0	5000
10841	M18	18.0	18.0	4000
10842	M20	20.0	20.0	2000
10224	M22	22.0	22.0	2000

BSP/Gaz

Polyéthylène basse densité jaune

Référence	Taille de filetage	Dimensions (mm)		Qté par sac
		h	d	
10351	1/4" x 19	11.0	13.0	10000
10492	3/8" x 19	12.0	16.0	5000
10308*	1/2" x 14	15.0	21.2	4000
12373*†	5/8" x 14	18.5	23.0	3000
10701	3/4" x 14	23.8	26.3	1500
12375*	7/8" x 14	25.0	29.5	1500
12376*	1" x 11	18.0	34.0	1500

* Style de languette différent

† Disponible avec trou d'évent

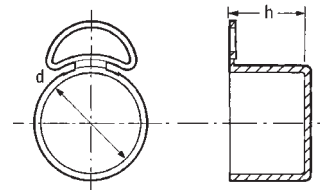

UNF/JIC

Polyéthylène basse densité bleu

Référence	Taille de filetage	Dimensions (mm)		Qté par sac
		h	d	
18390*	3/8" x 24	11.1	9.2	4000
18305	1/2" x 20	11.7	12.4	5000
18306*	9/16" x 18	12.1	14.0	5000
10348*	5/8" x 18	12.1	15.5	5000
16245*	11/16" x 16	12.1	17.1	5000
10349*	3/4" x 16	14.2	18.8	4000
16246*	13/16" x 16	14.2	20.4	4000
10702	7/8" x 14	16.5	22.0	2000
16247	1" x 14	16.5	25.0	2000
110002	11/16" x 12	19.0	26.7	2000
16248	13/16" x 12	19.0	29.8	1000
18311*	15/16" x 12	19.0	33.1	1000
16249*	17/16" x 12	19.0	36.4	1000
18405*	111/16" x 12	21.0	42.4	800
18406*	17/8" x 12	24.1	47.5	500

Capés à languettes

SR 6110

EVA (Ethylène-acétate de vinyle) jaune

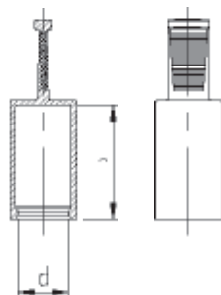

- Large languette pour un démontage aisé
- La lèvres intérieure prévient de la pollution par poussière
- La matière permet une bonne résistance et une flexibilité accrue

Référence	Dimensions (mm)		Qté par sac
	d	h	
464885	4.0	20.2	500
464886	5.0	20.0	500
464887	6.0	20.0	500
464888	8.0	20.0	500
464889	9.0	20.0	500
464890	10.0	20.0	500
464891	11.0	20.0	500
464892	12.0	20.0	500
464893	13.0	20.0	500
464894	14.0	20.0	500
464895	15.0	20.0	500
464896	16.0	20.0	500
464897	18.0	20.0	500
464898	20.0	20.0	500
464899	20.0	30.0	500
464900	24.0	20.0	500

Capés a dépose facile

SR1033

Polyéthylène basse densité

- Languette déchirable pour démontage facile
- Type 1 pour la protection des filetages UNF/JIC
- Type 2 pour la protection des filetages NPT
- Ces capes couvrent de nombreuses applications

Type 1

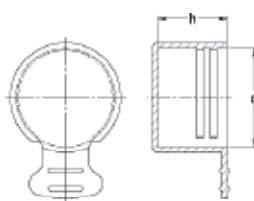

Type 2

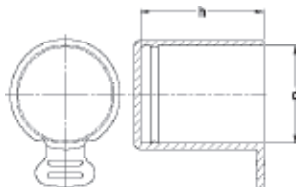

Type 1

Référence		Filetage UNF/JIC	Dimensions (mm)		Qté par sac
Bleu	Naturel		h	d	
TS3A	TS3B	3/8" - 24	11.1	9.3	13000
TS4A	TS4B	7/16" - 20	11.7	11.0	11000
TS5A	TS5B	1/2" - 20	11.7	12.5	9000
TS6A	TS6B	9/16" - 18	12.1	14.0	7000
TS7A	TS7B	11/16" - 16	12.1	17.2	5000
TS8A	TS8B	3/4" - 16	14.2	18.8	3500
TS9A	TS9B	13/16" - 16	14.2	20.4	3000
TS10A	TS10B	7/8" - 14	16.5	22.2	4500
TS11A	TS11B	1" - 14	16.5	25.0	4000
TS12A	TS12B	1-1/16" - 12	19.1	26.8	3000
TS13A	TS13B	1-3/16" - 12	19.1	29.8	2700
TS16A	TS16B	1-5/16" - 12	19.1	33.1	2200
TS17A	TS17B	1-7/16" - 12	19.1	36.4	200
TS20A	TS20B	1-5/8" - 12	21.0	41.0	1300
TS21A	TS21B	1-11/16" - 12	21.0	42.4	1200
TS24A	TS24B	1-7/8" - 12	24.1	47.5	900
TS32A	TS32B	2-1/2" - 12	30.5	63.7	400

Type 2

Référence	Couleur	Filetage BSP / NPT	Dimensions (mm)		Qté par sac
			h	d	
Y1/8A	Bleu	1/8"	8.1	9.8	5000
Y1/4A	Bleu	1/4"	12.5	13.5	5000
Y3/8A	Bleu	3/8"	12.5	16.9	5500
Y1/2A	Bleu	1/2"	16.3	20.8	5500
Y3/4A	Bleu	3/4"	16.0	26.2	4000
Y1A	Bleu	1"	19.9	33.2	2000
Y1-1/4A	Bleu	1-1/4"	21.3	41.7	1300
Y1-1/2A	Bleu	1-1/2"	21.6	47.9	1000
Y2A	Bleu	2"	22.6	59.4	600

Capés de protection d'arbre de transmission

SR 1079

Type 1 - Polyéthylène basse densité jaune

- S'adapte aux arbres de type DIN 748, IEC 600-72 et ISO R775
- Protection de l'arbre et masquage de l'épaulement

Type 2 - PVC souple jaune

- Pour arbres de type DIN 748, IEC 600-72 et ISO R775
- Résiste à la torsion, aux fissures, à l'huile et à la plupart des produits chimiques.

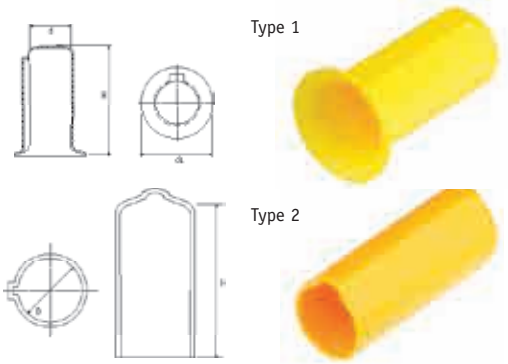

Type 1 - Polyéthylène basse densité jaune

Référence	Axe d (mm)	Dimensions (mm)		Qté par sac
		d1	H	
467003	9.0	14.5	25.0	500
467004	10.0	16.0	30.0	500
467005	11.0	17.5	30.0	500
467006	14.0	22.5	35.0	500
467007	15.0	25.5	35.0	500
467008	16.0	25.5	50.0	500
467009	19.0	30.5	50.0	400
467010	20.0	32.0	60.0	250
467011	22.0	35.5	60.0	250
467012	24.0	38.5	60.0	200
467013	25.0	40.0	70.0	200
467014	28.0	45.0	70.0	150
467015	30.0	48.0	95.0	100
467016	32.0	51.0	95.0	100
467017	35.0	56.0	95.0	100
467018	38.0	61.0	95.0	100
467019	42.0	67.0	130.0	75
467020	45.0	72.0	130.0	50
467021	48.0	77.0	130.0	100
467022	55.0	88.0	130.0	100
467023	60.0	96.0	165.0	25
467024	65.0	104.0	165.0	75
467025	70.0	108.0	165.0	75
467026	75.0	112.0	165.0	75

Type 2 - PVC souple jaune

Référence	Axe d (mm)	Dimensions (mm)		Qté par sac
		D	H	
SPWJ-10	10.0	10.0	50.0	1500
SPWJ-11	11.0	11.0	50.0	1500
SPWJ-14	14.0	14.0	50.0	1500
SPWJ-16	16.0	16.0	60.0	1000
SPWJ-19	19.0	19.0	60.0	1000
SPWJ-20	20.0	20.0	60.0	1000
SPWJ-22	22.0	22.0	70.0	750
SPWJ-24	24.0	24.0	70.0	750
SPWJ-25	25.0	25.0	70.0	500
SPWJ-28	28.0	28.0	80.0	500
SPWJ-30	30.0	30.0	80.0	400
SPWJ-32	32.0	32.0	100.0	250
SPWJ-35	35.0	35.0	100.0	200
SPWJ-38	38.0	38.0	100.0	200
SPWJ-42	42.0	42.0	130.0	150
SPWJ-45	45.0	45.0	130.0	150
SPWJ-48	48.0	48.0	130.0	100
SPWJ-55	55.0	55.0	130.0	100
SPWJ-60	60.0	60.0	140.0	100
SPWJ-65	65.0	65.0	140.0	100
SPWJ-70	70.0	70.0	140.0	100
SPWJ-75	75.0	75.0	140.0	100

Référence		Type	Dimensions (mm)		Qté par sac
PVC Noir	vinyl vert		d	h	
1340240	1340241	2	4.0	24.0	10000
12696	12226	1	5.0	23.5	10000
12697	12227	2	6.0	25.0	10000
1287250	1287249	2	7.0	24.0	5000
1287253	1287252	2	8.0	24.5	8000
12700	12230	1	9.0	25.0	3500
1341980	1341979	2	10.0	29.5	2500
12702	12232	2	11.0	29.0	4500
12703	12233	1	12.0	29.0	4000
1341983	1341982	2	13.0	29.0	3500
12705	12235	1	14.0	29.0	1500
12706	12236	1	15.0	29.5	2500
12707	12237	1	16.0	28.0	2500
12708	12238	1	17.0	29.5	2000
12709	12239	2	18.0	28.5	2000
1287247	1287246	2	19.0	29.5	2000
1341986	1341985	2	20.0	28.5	1600
12712	12242	1	21.0	34.5	1300
1341976	1341977	2	22.0	34.0	1200
12714	12244	2	23.0	34.5	1000
1341990	1341989	2	24.0	34.0	1000
12716	12246	2	25.0	34.5	1000
12717	12247	2	26.0	34.5	900
12718	12248	2	27.0	33.5	900
1287256	1287255	2	28.0	33.5	800
12720	12250	2	29.0	35.0	800
1287242	1287244	2	30.0	34.5	600

Capés Moss

SR 1020

PVC noir ou vinyl vert

- Très bonne résistance à la fragmentation
- Convient parfaitement pour protéger des applications filetéés
- Le VINYL VERT résiste aux huiles et aux graisses

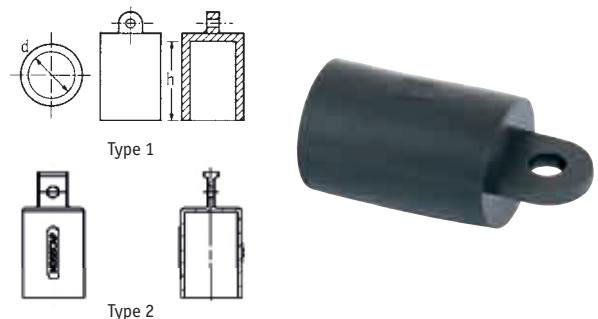

Flexicaps

SR 1044

Type 1 : PVC flexible noir (80 Shore)

- PVC flexible et durable
- Convient à une multitude d'applications

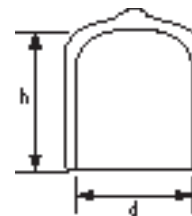

Référence	Pour filetage			Dimensions (mm)		Qté par sac
	Métrique	BSP	UNF	d	h	
FCWA-0020-013	-	-	-	2.0	13.0	5000
FCWA-0028-013	M3	-	-	2.8	13.0	5000
FCWA-0032-013	-	-	-	3.2	13.0	5000
FCWA-0036-013	M4	-	-	3.6	13.0	5000
FCWA-0036-019	M4	-	-	3.6	19.0	5000
FCWA-0039-013	-	-	-	3.9	13.0	5000
FCWA-0039-019	-	-	-	3.9	19.0	5000
FCWA-0039-025	-	-	-	3.9	25.0	5000
FCWA-0044-013	M5	-	3/16"	4.4	13.0	5000
FCWA-0044-025	M5	-	3/16"	4.4	25.0	5000
FCWA-0048-013	M5	-	3/16"	4.8	13.0	5000
FCWA-0048-019	M5	-	3/16"	4.8	19.0	5000
FCWA-0048-025	M5	-	3/16"	4.8	25.0	5000
FCWA-0052-013	-	-	-	5.2	13.0	5000
FCWA-0052-019	-	-	-	5.2	19.0	5000
FCWA-0052-025	-	-	-	5.2	25.0	5000
FCWA-0055-013	-	-	-	5.5	13.0	5000
FCWA-0055-019	-	-	-	5.5	19.0	5000
FCWA-0059-013	M6	-	1/4"	5.9	13.0	5000
FCWA-0059-019	M6	-	1/4"	5.9	19.0	5000
FCWA-0059-025	M6	-	1/4"	5.9	25.0	5000
FCWA-0064-013	-	-	-	6.4	13.0	5000
FCWA-0064-025	-	-	-	6.4	25.0	5000
FCWA-0070-013	-	-	-	7.0	13.0	5000
FCWA-0070-019	-	-	-	7.0	19.0	5000
FCWA-0077-013	M8	-	5/16"	7.7	13.0	5000
FCWA-0077-019	M8	-	5/16"	7.7	19.0	5000
FCWA-0070-025	-	-	-	7.0	25.0	5000
FCWA-0077-025	M8	-	5/16"	7.7	25.0	5000
FCWA-0079-013	-	-	-	7.9	13.0	5000
FCWA-0079-019	M8	-	5/16"	7.9	19.0	5000
FCWA-0079-025	M8	-	5/16"	7.9	25.0	5000
FCWA-0083-013	-	-	-	8.3	13.0	5000
FCWA-0083-019	-	-	-	8.3	19.0	5000
FCWA-0083-025	-	-	-	8.3	25.0	5000
FCWA-0087-013	-	-	-	8.7	13.0	5000
FCWA-0087-019	-	-	-	8.7	19.0	5000
FCWA-0087-025	-	-	-	8.7	25.0	5000
FCWA-0095-013	M10	1/8"	3/8"	9.5	13.0	5000
FCWA-0095-019	M10	1/8"	3/8"	9.5	19.0	5000
FCWA-0095-025	M10	1/8"	3/8"	9.5	25.0	5000
FCWA-0103-013	-	-	-	10.3	13.0	5000
FCWA-0103-019	-	-	-	10.3	19.0	5000
FCWA-0103-025	-	-	-	10.3	25.0	2500
FCWA-0111-013	M12	-	7/16"	11.1	13.0	5000
FCWA-0111-019	M12	-	7/16"	11.1	19.0	5000
FCWA-0111-025	M12	-	7/16"	11.1	25.0	2500
FCWA-0119-013	M12	-	1/2"	11.9	13.0	5000
FCWA-0119-019	M12	-	1/2"	11.9	19.0	5000
FCWA-0119-025	M12	-	1/2"	11.9	25.0	2500
FCWA-0127-013	-	1/4"	1/2"	12.7	13.0	5000

Référence	Pour filetage			Dimensions (mm)		Qté par sac
	métrique	BSP	UNF	d	h	
FCWA-0127-019	-	1/4"	1/2"	12.7	19.0	5000
FCWA-0127-025	-	1/4"	1/2"	12.7	25.0	2500
FCWA-0135-013	M14	-	-	13.5	13.0	5000
FCWA-0135-019	M14	-	-	13.5	19.0	5000
FCWA-0135-025	M14	-	-	13.5	25.0	5000
FCWA-0138-013	M14	-	-	13.8	13.0	5000
FCWA-0138-019	M14	-	-	13.8	19.0	2500
FCWA-0138-025	M14	-	-	13.8	25.0	2500
FCWA-0143-013	M15	-	-	14.3	13.0	5000
FCWA-0143-019	M15	-	-	14.3	19.0	2500
FCWA-0143-025	M15	-	-	14.3	25.0	5000
FCWA-0152-013	-	-	-	15.2	13.0	5000
FCWA-0152-019	-	-	-	15.2	19.0	5000
FCWA-0152-025	-	-	-	15.2	25.0	5000
FCWA-0159-013	M16	3/8"	-	15.9	13.0	5000
FCWA-0159-019	M16	3/8"	-	15.9	19.0	2500
FCWA-0159-025	M16	3/8"	-	15.9	25.0	2500
FCWA-0174-013	M18	-	-	17.4	13.0	2500
FCWA-0174-019	M18	-	-	17.4	19.0	2000
FCWA-0174-025	M18	-	-	17.4	25.0	2500
FCWA-0191-013	M20	-	3/4"	19.1	13.0	2500
FCWA-0191-019	M20	-	3/4"	19.1	19.0	2500
FCWA-0191-025	M20	-	3/4"	19.1	25.0	2500
FCWA-0199-013	-	-	-	19.9	13.0	2500
FCWA-0199-019	-	-	-	19.9	19.0	2500
FCWA-0199-025	-	-	-	19.9	25.0	2500
FCWA-0206-013	-	1/2"	-	20.6	13.0	2500
FCWA-0206-025	-	1/2"	-	20.6	25.0	1250
FCWA-0206-038	-	1/2"	-	20.6	38.0	1000
FCWA-0214-013	M22	-	-	21.4	13.0	2500
FCWA-0214-025	M22	-	-	21.4	25.0	1250
FCWA-0214-038	M22	-	-	21.4	38.0	1200
FCWA-0222-013	-	5/8"	7/8"	22.2	13.0	2500
FCWA-0222-025	-	5/8"	7/8"	22.2	25.0	2500
FCWA-0222-038	-	5/8"	7/8"	22.2	38.0	1250
FCWA-0238-013	M24	-	-	23.8	13.0	2500
FCWA-0238-025	M24	-	-	23.8	25.0	1250
FCWA-0238-038	M24	-	-	23.8	38.0	1000
FCWA-0246-013	M25	-	-	24.6	13.0	2500
FCWA-0246-025	M25	-	-	24.6	25.0	1000
FCWA-0246-038	M25	-	-	24.6	38.0	1000
FCWA-0254-013	-	-	1"	25.4	13.0	2500
FCWA-0254-025	-	-	1"	25.4	25.0	1000
FCWA-0254-038	-	-	1"	25.4	38.0	1250
FCWA-0263-013	M27	3/4"	-	26.3	13.0	2500
FCWA-0263-025	M27	3/4"	-	26.3	25.0	1250
FCWA-0263-038	M27	3/4"	-	26.3	38.0	1000
FCWA-0269-013	M27	-	-	26.9	13.0	3000
FCWA-0269-025	M27	-	-	26.9	25.0	1500
FCWA-0269-038	M27	-	-	26.9	38.0	1250
FCWA-0286-025	M30	7/8"	1 1/8"	28.6	25.0	1000
FCWA-0286-038	M30	7/8"	1 1/8"	28.6	38.0	500
FCWA-0286-050	M30	7/8"	1 1/8"	28.6	50.0	500
FCWA-0302-025	-	7/8"	-	30.2	25.0	1000
FCWA-0302-038	-	7/8"	-	30.2	38.0	1000

SUITE PAGE SUIVANTE

Flexicaps SUITE

SR 1044

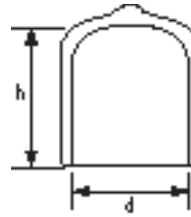

Référence	Pour filetage			Dimensions (mm)		Qté par sac
	métrique	BSP	UNF	d	h	
FCWA-0302-050	-	7/8"	-	30.2	50.0	750
FCWA-0318-025	-	1"	1 1/4"	31.8	25.0	1000
FCWA-0318-038	-	1"	1 1/4"	31.8	38.0	700
FCWA-0318-050	-	1"	1 1/4"	31.8	50.0	750
FCWA-0349-025	M35	-	1 3/8"	34.9	25.0	1000
FCWA-0349-038	M35	-	1 3/8"	34.9	38.0	650
FCWA-0349-050	M35	-	1 3/8"	34.9	50.0	500
FCWA-0381-025	M39	-	1 1/2"	38.1	25.0	1000
FCWA-0381-038	M39	-	1 1/2"	38.1	38.0	600
FCWA-0381-050	M39	-	1 1/2"	38.1	50.0	500
FCWA-0413-025	M42	1 1/4"	-	41.3	25.0	900
FCWA-0413-038	M42	1 1/4"	-	41.3	38.0	500
FCWA-0413-050	M42	1 1/4"	-	41.3	50.0	400
FCWA-0445-025	M45	1 3/8"	-	44.5	25.0	500
FCWA-0445-038	M45	1 3/8"	-	44.5	38.0	500
FCWA-0445-050	M45	1 3/8"	-	44.5	50.0	400
FCWA-0476-025	M48	1 1/2"	-	47.6	25.0	625
FCWA-0476-038	M48	1 1/2"	-	47.6	38.0	400

Référence	Pour filetage			Dimensions (mm)		Qté par sac
	Métrique	BSP	UNF	d	h	
FCWA-0476-050	-	1 1/2"	-	47.6	50.0	350
FCWA-0508-025	-	-	2"	50.8	25.0	550
FCWA-0508-038	-	-	2"	50.8	38.0	400
FCWA-0508-050	-	-	2"	50.8	50.0	200
FCWA-0539-038	-	1 3/4"	-	53.9	38.0	400
FCWA-0539-050	-	1 3/4"	-	53.9	50.0	200
FCWA-0572-038	M58	2 1/4"	-	57.2	38.0	250
FCWA-0572-050	M58	2 1/4"	-	57.2	50.0	200
FCWA-0603-038	-	2 3/8"	-	60.3	38.0	250
FCWA-0603-050	-	2 3/8"	-	60.3	50.0	250
FCWA-0635-038	-	2 1/2"	-	63.5	38.0	250
FCWA-0635-050	-	2 1/2"	-	63.5	50.0	125
FCWA-0660-038	-	2 1/4"	-	66.0	38.0	200
FCWA-0660-025	-	2 1/4"	-	66.0	25.0	200
FCWA-0667-038	-	-	-	66.7	38.0	150
FCWA-0698-038	-	-	-	69.8	38.0	250
FCWA-0698-050	-	-	-	69.8	50.0	200
FCWA-0762-038	-	3"	-	76.2	38.0	200
FCWA-0762-050	-	3"	-	76.2	50.0	150

Type 2 : PVC souple rouge (60 Shore)

- PVC plus tendre et plus souple permettant un montage facile
- La couleur rouge vif offre une meilleure identification et une réduction des risques pour la santé et la sécurité

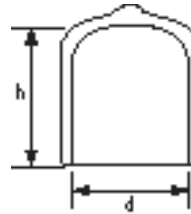

Référence	Pour filetage			Dimensions (mm)		Qté par sac
	Métrique	BSP	UNF	d	h	
FCZF-0077-013	M8	-	5/16"	7.7	13.0	5000
FCZF-0079-013	-	-	-	7.9	13.0	5000
FCZF-0087-013	-	-	-	8.7	13.0	5000
FCZF-0095-013	-	-	-	9.5	13.0	5000
FCZF-0103-013	-	-	-	10.3	13.0	5000
FCZF-0111-013	M12	-	7/16"	11.1	13.0	5000
FCZF-0119-013	M12	-	1/2"	11.9	13.0	5000
FCZF-0127-013	M14	1/4"	1/2"	12.7	13.0	5000
FCZF-0138-013	M14	-	-	13.8	13.0	5000
FCZF-0143-013	M15	-	-	14.3	13.0	5000
FCZF-0152-013	-	-	-	15.2	13.0	5000
FCZF-0159-013	M16	3/8"	-	15.9	13.0	5000
FCZF-0174-013	M18	-	-	17.4	13.0	2500
FCZF-0191-025	M20	-	3/4"	19.1	25.0	2500
FCZF-0206-025	-	1/2"	-	20.6	25.0	1250
FCZF-0214-025	M22	-	-	21.4	25.0	1250
FCZF-0222-025	-	5/8"	7/8"	22.2	25.0	1250

Référence	Pour filetage			Dimensions (mm)		Qté par sac
	Métrique	BSP	UNF	d	h	
FCZF-0238-025	M24	-	-	23.8	25.0	1250
FCZF-0246-025	M25	-	-	24.6	25.0	1000
FCZF-0254-025	-	-	1"	25.4	25.0	1000
FCZF-0263-025	M27	3/4"	-	26.3	25.0	1250
FCZF-0286-025	M30	7/8"	1 1/8"	28.6	25.0	1000
FCZF-0302-025	-	7/8"	-	30.2	25.0	1000
FCZF-0318-025	-	1"	1 1/4"	31.8	25.0	1000
FCZF-0349-025	M35	-	1 3/8"	34.9	25.0	1000
FCZF-0381-025	M39	-	1 1/2"	38.1	25.0	1000
FCZF-0413-025	M42	1 1/4"	-	41.3	25.0	900
FCZF-0445-025	M45	1 3/8"	-	44.5	25.0	500
FCZF-0476-038	M48	1 1/2"	-	47.6	38.0	400
FCZF-0508-038	-	-	2"	50.8	38.0	400
FCZF-0539-038	-	1 3/4"	-	53.9	38.0	400
FCZF-0572-038	M58	-	-	57.2	38.0	250
FCZF-0603-038	-	2 3/8"	-	60.3	38.0	250
FCZF-0635-038	-	2 1/2"	-	63.5	38.0	250
FCZF-0698-050	-	-	-	69.8	50.0	200

Cape thermorétractable

SR 1180

Polyoléfine

- Très bonnes propriétés d'étanchéité
- Résistance atmosphérique et UV
- Température d'utilisation : -55°C à +110°C
- Température min. de rétreint +120°C
- Revêtement intérieur avec couche adhésive

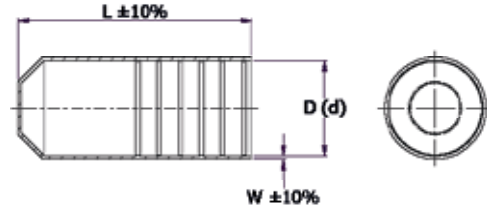

Référence	Dimensions (mm)				Qté par sac
	A l'origine	Après rétreint			
	D (Min.)	d (Max.)	L	w	
498776	12.0	4.0	40.0	2.6	100
498777	14.0	5.0	45.0	2.2	100
498788	200.0	90.0	160.0	4.2	6
498778	20.0	6.0	55.0	2.8	50
498779	25.0	8.5	68.0	2.8	50
498780	35.0	16.0	83.0	3.3	50
498789	14.0	5.0	55.0	2.2	20
498790	42.0	15.0	110.0	3.3	20
498791	55.0	23.0	140.0	3.8	6
498782	55.0	26.0	103.0	3.5	10
498792	62.0	23.0	140.0	3.8	6
498783	75.0	36.0	120.0	4.0	10
498793	75.0	32.0	150.0	4.0	10
498794	75.0	36.0	170.0	4.2	10
498795	105.0	45.0	150.0	4.0	10
498784	100.0	52.0	140.0	4.0	1
498785	120.0	60.0	150.0	4.0	1
498786	145.0	60.0	150.0	4.0	1
498787	160.0	82.0	150.0	4.0	9

Capuchon de protection

SR5763

PEBD - Naturel

- Très bonne protection des pas de vis, axes lisses, extrémités de tiges, etc.

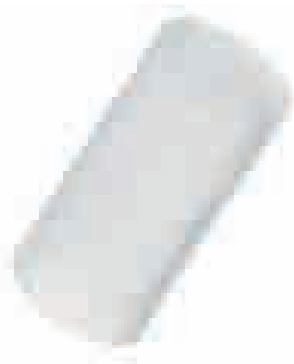

Référence	Dimensions (mm)			Qté par sac
	A	B	C	
118042300003	4.0	6.0	23.0	500
118051500003	4.7	7.0	15.0	500
118052400003	5.0	7.0	24.0	500
118062500003	6.0	8.0	25.0	500
118072500003	7.0	9.0	25.0	500
118082500003	8.0	10.0	25.0	500
118102500003	10.0	12.0	25.0	500
118032200003	3.5	5.0	23.0	500

Flexicaps à languette

SR 1066

Type 1 : PVC flexible noir (80 Shore)

Type 2 : PVC flexible rouge (60 Shore)

- Convient à une multitude d'applications
- Languette pour dépose facile



Type 1 : PVC noir

Référence	Pour filetage			Dimensions (mm)		Qté par sac
	métrique	BSP	UNF	d	h	
PCWA-0036-013	M4	-	-	3.6	13.0	5000
PCWA-0048-013	M4	-	-	4.8	13.0	5000
PCWA-0053-013	M6	-	7/32"	5.3	13.0	5000
PCWA-0061-013	-	-	1/4"	6.1	13.0	5000
PCWA-0075-013	-	-	-	7.5	13.0	5000
PCWA-0075-025	-	-	-	7.5	25.0	5000
PCWA-0077-013	M8	-	5/16"	7.7	13.0	7500
PCWA-0077-025	-	-	-	7.7	25.0	5000
PCWA-0087-013	-	-	-	8.7	13.0	5000
PCWA-0093-013	M10	1/8"	3/8"	9.3	13.0	2500
PCWA-0093-025	-	-	-	9.3	25.0	3000
PCWA-0097-013	-	-	-	9.7	13.0	2500
PCWA-0097-025	-	-	-	9.7	25.0	2500
PCWA-0108-013	-	-	7/16"	10.8	13.0	5000
PCWA-0108-025	-	-	-	10.8	25.0	5000
PCWA-0111-013	-	-	-	11.1	13.0	2500
PCWA-0111-025	-	-	-	11.1	25.0	5000
PCWA-0119-013	M12	-	1/2"	11.9	13.0	5000
PCWA-0119-025	-	-	-	11.9	25.0	3000
PCWA-0124-025	-	1/4"	1/2"	12.4	25.0	5000
PCWA-0124-013	-	1/4"	1/2"	12.4	13.0	5000
PCWA-0132-013	M14	-	17/32"	13.2	13.0	5000
PCWA-0132-025	-	-	-	13.2	25.0	2500
PCWA-0143-025	M15	-	9/16"	14.3	25.0	2500
PCWA-0153-013	M16	-	-	15.3	13.0	2500
PCWA-0153-025	-	-	-	15.3	25.0	2000
PCWA-0159-025	-	3/8"	5/8"	15.9	25.0	2000
PCWA-0163-013	M18	-	11/16"	16.3	13.0	2500
PCWA-0163-025	-	-	-	16.3	25.0	1250
PCWA-0174-013	M18	-	-	17.4	13.0	2500
PCWA-0174-025	M18	-	-	17.4	25.0	2500
PCWA-0188-013	M20	-	3/4"	18.8	13.0	2500
PCWA-0188-025	-	-	-	18.8	25.0	1250
PCWA-0200-013	-	-	-	20.0	13.0	2500
PCWA-0200-025	-	-	-	20.0	25.0	2500
PCWA-0206-013	M22	1/2"	13/16"	20.6	13.0	2500
PCWA-0206-025	-	-	-	20.6	25.0	2000
PCWA-0220-025	-	5/8"	7/8"	22.0	25.0	1500
PCWA-0238-025	-	-	-	23.8	25.0	1500
PCWA-0246-013	M25	-	-	24.6	13.0	1500
PCWA-0246-025	M25	-	-	24.6	25.0	1500
PCWA-0251-025	M26	-	1"	25.1	25.0	1500
PCWA-0269-025	-	-	-	26.9	25.0	1000
PCWA-0286-025	M30	7/8"	11/8"	28.6	25.0	1500
PCWA-0286-038	M30	7/8"	11/8"	28.6	38.0	1500
PCWA-0312-038	M32	1"	11/4"	31.2	38.0	350
PCWA-0349-025	M35	-	13/8"	34.9	25.0	350
PCWA-0349-038	M35	-	13/8"	34.9	38.0	350
PCWA-0381-038	M39	-	11/2"	38.1	38.0	350
PCWA-0381-050	M39	-	11/2"	38.1	50.0	350
PCWA-0408-038	-	-	15/8"	40.8	38.0	350
PCWA-0445-038	M45	13/8"	-	44.5	38.0	350
PCWA-0445-050	M45	13/8"	-	44.5	50.0	350
PCWA-0508-050	-	-	2"	50.8	50.0	200

Type 2 : PVC rouge

Référence	Pour filetage			Dimensions (mm)		Qté par sac
	métrique	BSP	UNF	d	h	
PCZF-0075-013	-	-	-	7.5	13.0	5000
PCZF-0075-025	M8	-	-	7.5	25.0	5000
PCZF-0077-013	-	-	5/16"	7.7	13.0	7500
PCZF-0077-025	-	-	-	7.7	25.0	5000
PCZF-0087-013	-	-	-	8.7	13.0	5000
PCZF-0087-025	M10	-	-	8.7	13.0	5000
PCZF-0093-013	-	1/8"	3/8"	9.3	13.0	5000
PCZF-0097-013	-	-	-	9.7	13.0	2500
PCZF-0097-025	-	-	-	9.7	25.0	2500
PCZF-0108-013	-	-	7/16"	10.8	13.0	5000
PCZF-0108-025	-	-	-	10.8	25.0	5000
PCZF-0111-013	-	-	-	11.1	13.0	2500
PCZF-0111-025	M12	-	-	11.1	25.0	2500
PCZF-0119-013	-	-	1/2"	11.9	13.0	5000
PCZF-0119-025	-	-	-	11.9	25.0	5000
PCZF-0124-025	M14	1/4"	1/2"	12.4	25.0	5000
PCZF-0132-025	M15	-	9/16"	13.2	25.0	5000
PCZF-0143-025	M16	-	-	14.3	25.0	2500
PCZF-0153-025	-	-	-	15.3	25.0	2000
PCZF-0159-025	M18	-	5/8"	15.9	25.0	2000
PCZF-0174-013	M18	-	-	17.4	13.0	2500
PCZF-0174-025	M20	-	-	17.4	25.0	2500
PCZF-0188-013	-	-	3/4"	18.8	13.0	2500
PCZF-0188-025	-	-	-	18.8	25.0	1250
PCZF-0200-013	-	-	-	20.0	13.0	2500
PCZF-0200-025	M22	-	-	20.0	25.0	2500
PCZF-0206-013	-	1/2"	13/16"	20.6	13.0	2500
PCZF-0206-025	-	-	-	20.6	25.0	2000
PCZF-0220-025	-	5/8"	7/8"	22.0	25.0	2000
PCZF-0238-025	M25	-	-	23.8	25.0	1500
PCZF-0251-025	-	-	1"	25.1	25.0	1500
PCZF-0269-025	M30	-	-	26.9	25.0	1500
PCZF-0286-038	M32	7/8"	11/8"	28.6	38.0	1500
PCZF-0312-038	M35	1"	11/4"	31.2	38.0	500
PCZF-0349-025	M35	-	13/8"	34.9	25.0	350
PCZF-0349-038	M39	-	13/8"	34.9	38.0	350
PCZF-0381-038	M39	-	11/2"	38.1	38.0	350
PCZF-0413-038	M42	11/4"	-	41.3	38.0	350

Bouchons filetés avec joint torique

SR 1125

PEHD jaune

- Montage et démontage avec un tournevis ou une clé, avec un outillage électrique ou à la main

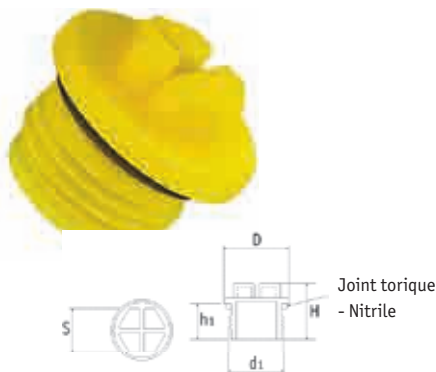

Filetage métrique

Référence	Filet (d1)	Dimensions (mm)				Qté par sac
		D	H	h1	S	
498659	M8 x 1	12.5	17.0	10.0	6.0	500
498660	M10 x 1	14.5	17.2	10.0	7.0	500
498661	M12 x 1	17.0	17.2	10.0	10.0	500
498662	M10 x 1.5	14.5	19.2	12.0	7.0	500
498663	M12 x 1.5	17.0	19.2	12.0	10.0	500
498664	M14 x 1.5	22.0	19.2	12.0	10.0	500
498540	M16 x 1.5	24.0	20.4	12.0	13.0	500
498541	M18 x 1.5	24.0	20.4	12.0	13.0	500
498542	M20 x 1.5	26.0	20.4	12.0	15.0	250
498665	M22 x 1.5	28.0	20.4	12.0	15.0	250
498543	M24 x 1.5	30.0	20.4	12.0	17.0	250
498544	M26 x 1.5	32.0	20.4	12.0	19.0	250
498546	M30 x 1.5	38.0	20.6	12.0	22.0	250
498547	M32 x 1.5	40.0	20.6	12.0	24.0	250
498666	M36 x 1.5	45.0	20.6	12.0	24.0	100
498667	M38 x 1.5	48.0	20.6	12.0	24.0	100
498668	M27 x 2.0	33.0	24.6	15.0	19.0	250
498548	M30 x 2.0	38.0	24.6	15.0	22.0	250
498549	M33 x 2.0	40.0	24.6	15.0	24.0	250
498550	M36 x 2.0	45.0	24.6	15.0	24.0	100
498669	M42 x 2.0	50.0	24.6	15.0	24.0	100
498551	M45 x 2.0	52.0	25.0	15.0	30.0	100
498670	M48 x 2.0	55.0	25.0	15.0	30.0	100
498671	M52 x 2.0	60.0	25.0	15.0	30.0	100

Filetage UNF

Référence	Filet (d1)	Dimensions (mm)				Qté par sac
		D	H	h1	S	
498672	3/8" x 24	14.0	17.2	10.0	7.0	500
498673	7/16" x 20	16.0	19.7	12.5	10.0	500
498674	1/2" x 20	19.0	20.9	12.5	10.0	500
498675	9/16" x 18	21.0	20.9	12.5	10.0	500
498552	5/8" x 18	22.0	20.9	12.5	13.0	500
498676	3/4" x 16	27.0	21.9	13.5	13.0	500
498677	7/8" x 14	28.0	21.9	13.5	15.0	250
498553	1" x 14	31.0	22.1	13.5	17.0	250
498554	1 1/16" x 12	35.0	22.6	14.0	19.0	250
498678	1 3/16" x 12	38.0	22.6	14.0	22.0	250
498555	1 5/16" x 12	42.0	24.0	14.0	24.0	250
498679	1 5/8" x 12	50.0	24.0	14.0	24.0	100
498680	1 7/8" x 12	55.0	24.0	14.0	30.0	100

Filetage BSP

Référence	Filet (d1)	Dimensions (mm)				Qté par sac
		D	H	h1	S	
498681	1/8" x 28	16.0	17.2	10.0	7.0	500
498682	1/4" x 19	19.0	19.7	12.5	10.0	500
498683	3/8" x 19	22.0	20.9	12.5	13.0	500
498556	1/2" x 14	27.0	21.9	13.5	15.0	500
498557	5/8" x 14	29.5	21.9	13.5	17.0	500
498558	3/4" x 14	32.0	21.9	13.5	19.0	250
498559	7/8" x 14	37.0	21.9	13.5	22.0	250
498684	1" x 11	40.0	23.6	15.0	24.0	250
498685	1 1/4" x 11	50.0	23.6	15.0	24.0	250
498686	1 1/2" x 11	56.0	25.0	15.0	30.0	100
498687	1 3/4" x 11	62.0	25.0	15.0	36.0	100
498688	2" x 11	68.0	25.0	15.0	36.0	100

Bouchon Slottex

SR 1117

Polyéthylène haute densité bleu

- Montage et démontage avec un tournevis ou une clé, avec un outillage électrique ou à la main

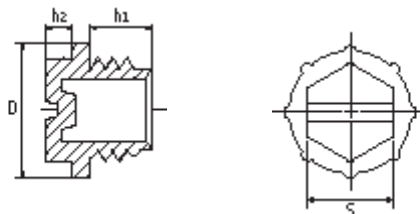

Référence	Filetage UNF	Dimensions (mm)				Qté par sac
		D	h1	h2	S	
B-3	7/16"-20	15.8	7.6	4.6	10.9	11000
B-4	1/2"-20	17.3	9.1	4.6	12.7	7500
B-5	9/16"-18	19.1	9.7	4.6	12.7	6000
B-6	5/8"-18	20.6	8.9	4.6	14.2	5000
B-7	3/4"-16	23.9	11.2	4.8	17.3	3500
B-8	7/8"-14	26.9	12.7	6.1	19.1	2100
B-9	1"-14	30.0	10.9	6.4	19.1	2000
B-10	1 1/16"-14	33.3	16.4	6.4	22.1	1200

Bouchon UNF standard

SR 5762

Polypropylène (PP) jaune / noir *

- Peut être mis en place ou retiré à la main à l'aide d'un tourne-vis ou une clef
- EN OPTION : Un joint torique permettra une étanchéité au serrage



Référence sans joint torique	Référence avec joint torique	Pour filetage	Dimensions (mm)				Qté par sac
			A	B	C	D	
BL3A	BL3L	7/16" x 20	10.9	15.8	4.57	9.91	10000
BL4A *	BL4B *	1/2" x 13	12.7	17.5	7.14	10.41	6000
BL5A	BL5K	9/16" x 18	12.7	19.1	4.57	10.67	6000
BL7A	BL7J	3/4" x 16	17.3	23.9	4.83	13.21	3000
BL8A	BL8H	7/8" x 14	19.1	26.9	6.1	14.22	2100
BL10A	BL10I	1 1/16" x 12	22.1	33.3	6.35	16.76	1200
BL11A	BL11D	1 3/16" x 12	25.4	38.1	7.62	17.78	850
BL12A	BL12H	1 5/16" x 12	27.18	40.89	7.37	17.78	700
BL13A	BL13D	1 5/8" x 12	28.58	42.75	7.62	19.56	1000
BL14A	BL14C	1 7/8" x 12	38.1	53.98	7.62	19.05	700

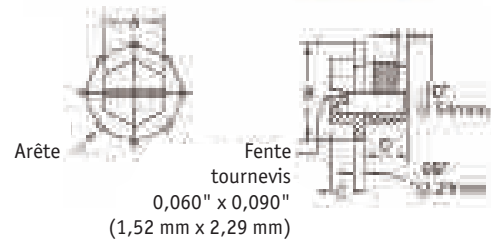

FACILITER VOTRE TRAVAIL :

ÉCHANTILLONS GRATUITS : essayez avant d'acheter

CONDITIONNEMENTS REDUITS : disponibles suivant vos besoins

LIVRAISONS RAPIDES : expédition le jour même

SERVICE COMMERCIAL : conseils dans le choix des produits.

Appelez au 01 48 17 50 00
www.essentracomponents.fr

Bouchon UNF à large collerette

SR 5761

Nylon et nitrile

- Bouchon fileté
- Couleur standard : jaune
- Le joint en nitrile apporte l'étanchéité au serrage
- Peut-être mis en place ou ôté à la main, avec un tourne-vis ou une clef
- Le Nylon supporte des températures intermittentes de -40°C to +100°C

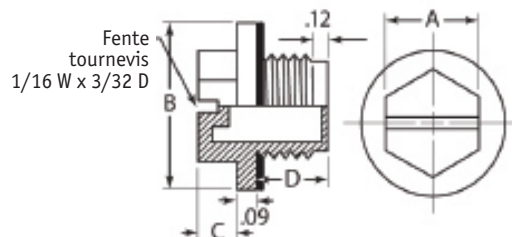

Référence	Pour filetage	Dimensions (mm)				Qté par sac
		A	B	C	D	
BLWF100A	7/16" x 20	12.7	19.6	4.5	9.9	5000
BLWF105A	1/2" x 20	12.7	21.6	4.5	10.2	5000
BLWF110A	9/16" x 18	12.7	23.2	4.5	10.6	2500
BLWF115A	3/4" x 16	19.0	28.7	4.8	13.2	2500
BLWF120A	7/8" x 14	19.0	32.6	6.1	14.2	2500
BLWF125A	1 1/16" x 12	25.4	40.0	6.3	16.7	1000
BLWF130A	1 3/16" x 12	25.4	43.7	7.6	17.7	1000
BLWF135A	1 5/16" x 12	25.4	47.4	7.3	17.7	1000
BLWF140A	1 5/8" x 12	28.5	56.3	7.6	19.5	500
BLWF145A	1 7/8" x 12	38.1	63.6	7.6	19.0	500

Bouchon UNF avec joint moulé

SR 5760

PEHD

- Souvent utilisé dans l'hydraulique
- Le joint évite les fuites et l'entrée de contaminants
- La collerette s'appuie sur la face afin d'empêcher l'entrée de contaminants
- Peut-être mis en place ou ôté à la main, avec un tourne-vis ou une clef

Tête à 12 points pour le serrage par douille ou clé

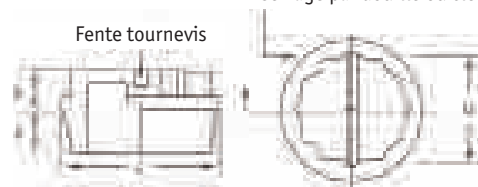

Référence	Pour filetage	Dimensions (mm)				Qté par sac
		A	B	C	D	
BLM3B	7/16" x 20	8.7	7.1	16.76	3/8"	8000
BLM3-24B	7/16" x 24	8.7	7.1	16.76	3/8"	8000
BLM4B	1/2" x 20	8.7	8.0	18.54	7/16"	6000
BLM5B	9/16" x 18	8.9	8.2	20.32	1/2"	6000
BLM6B	5/8" x 18	9.5	8.0	20.83	9/16"	5000
BLM7B	3/4" x 16	10.3	10.3	25.91	11/16"	3000

D* Taille de tête à 12 points - mesures en pouces

Référence	Pour filetage	Dimensions (mm)				Qté par sac
		A	B	C	D	
BLM8B	7/8" x 14	11.9	7.9	29.4	13/16"	2000
BLM9B	1" x 14	12.7	7.9	31.7	7/8"	1500
BLM10B	1 1/16" x 12	15.0	7.9	36.8	1"	1000
BLM11B	1 3/16" x 12	15.0	8.7	38.1	1-1/8"	1000
BLM12B	1 5/16" x 12	15.0	8.7	44.2	1-1/4"	1000
BLM13B	1 5/8" x 12	15.0	8.7	54.7	1-1/2"	700
BLM14B	1 7/8" x 12	15.0	8.7	55.5	1-5/8"	700

Bouchons de protection filetés

SR 1002

Polyéthylène basse densité rouge

- Tête pour prise facile
- Le filetage garantit un bon ajustage
- Protection idéale contre la poussière, l'humidité et la corrosion
- Très utilisée dans l'industrie hydraulique, pneumatique et la construction mécanique

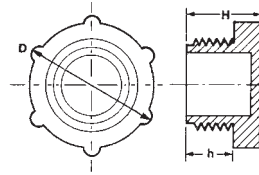

Métrique

Référence	Taille de filetage	Dimensions (mm)			Qté par sac
		D	h	H	
12011	M8 x 1	12.3	9.5	14.3	5000
12012	M10 x 1	15.3	10.4	14.6	5000
12013	M12 x 1	18.5	10.7	16.7	5000
12017*	M12 x 1.5	16.7	8.7	16.3	2500
12018*	M14 x 1.5	18.5	9.5	17.2	5000
12019	M16 x 1.5	22.0	12.5	17.2	3000
10458	M18 x 1.5	23.5	13.5	18.3	4000
12020	M20 x 1.5	26.3	14.0	18.2	3000
10128	M22 x 1.5	28.2	13.7	18.3	3000
12021	M24 x 1.5	31.3	13.8	18.5	2000
12022	M25 x 1.5	31.3	14.0	18.5	2500
12023	M26 x 1.5	32.7	13.8	18.7	2000
12030	M52 x 1.5	63.7	15.5	21.5	500

* Tête hexagonale.

UNF/JIC

Référence	Taille de filetage	Dimensions (mm)			Qté par sac
		D	h	H	
10498	5/16" x 18	14.5	7.4	12.0	5000
10709	5/16" x 24	14.8	7.4	12.3	5000
10692	3/8" x 24	13.7	9.5	14.0	5000
10763	7/16" x 20	17.4	11.0	16.1	5000
12031	7/16" x 24	17.8	7.1	12.1	5000
10696	1/2" x 20	18.5	10.5	15.3	5000
10668	9/16" x 18	22.6	10.7	15.4	5000
12033	9/16" x 24	18.9	9.0	13.6	5000
10940	5/8" x 18	21.0	10.0	14.8	5000
12965	5/8" x 24	20.7	10.0	14.8	5000
12786	1 1/16" x 16	25.6	13.5	18.1	3000
10575	3/4" x 16	27.0	13.8	18.7	3000
12827	1 3/16" x 16	26.7	13.5	18.1	2500
10326	7/8" x 14	28.8	13.6	18.5	2500
12785	1" x 14	32.0	13.2	17.8	2000
10460	1 1/16" x 12	33.4	13.8	18.4	2000
12359	1 1/16" x 14	33.3	13.7	18.3	2000
11506	1 3/16" x 12	36.8	13.5	18.3	1500
10671	1 5/16" x 12	39.3	11.0	16.3	1500
11752	1 3/8" x 12	50.6	12.9	17.3	800
11755	1 7/8" x 12	58.4	16.7	22.5	400
12040	2 1/2" x 12	73.6	15.0	20.6	300

BSP/Gaz

Référence	Taille de filetage	Dimensions (mm)			Qté par sac
		D	h	H	
10651	1/8" x 28	16.4	4.2	10.5	5000
10588	1/4" x 19	18.8	6.5	12.8	5000
10996	3/8" x 19	22.9	5.5	12.0	5000
10590	1/2" x 14	28.0	10.3	17.3	3000
10511	5/8" x 14	31.3	13.9	18.4	2500
10731	3/4" x 14	32.3	11.0	17.0	2000
11429	7/8" x 14	38.0	13.5	18.1	1500
10810	1" x 11	39.8	10.8	16.9	1500
10459	1 1/4" x 11	49.9	15.0	20.9	800
11242	1 1/2" x 11	55.2	10.8	16.9	600
10496	2" x 11	73.7	10.7	17.5	400
10319	3" x 11	105.0	11.3	16.5	150

Métrique

Référence	Taille de filetage	Dimensions (mm)			Qté par sac
		D	h	H	
12605	M14 x 1.5	21.5	8.0	12.5	5000
12606	M16 x 1.5	23.6	8.0	12.5	3000
18408	M20 x 1.5	29.5	8.0	13.0	3000
12597	M30 x 2.0	39.9	9.8	14.6	1500
12611	M36 x 2.0	45.6	10.5	21.5	1000
12578	M42 x 2.0	64.7	15.5	21.2	700
12602	M45 x 2.0	57.8	12.7	18.5	700
12612	M52 x 2.0	65.9	15.4	21.3	500

BSP/Gaz

Référence	Taille de filetage	Dimensions (mm)			Qté par sac
		D	h	H	
10101	1/4" x 19	20.5	6.0	9.2	5000
10102	3/8" x 19	24.1	6.2	9.6	5000
10103	1/2" x 14	30.4	6.1	9.2	3000
10105	5/8" x 14	30.2	6.0	9.2	2500
10106	3/4" x 14	34.0	6.1	9.1	2000
12613	3/4" x 14	33.2	6.8	12.5	2000
10107	1" x 11	40.2	5.7	9.0	1500
12614	1 1/4" x 11	49.5	12.9	18.7	800

Bouchons filetés montage rapide

SR 1009

Polyéthylène basse densité rouge

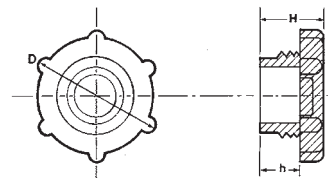

UNC/JIC

Référence	Taille de filetage	Dimensions (mm)			Qté par sac
		D	h	H	
10108	7/16" x 20	18.5	5.9	9.0	5000
10109	1/2" x 20	20.6	5.9	9.1	5000
10110	9/16" x 18	21.4	5.9	9.0	5000
10119	3/4" x 16	26.7	5.9	9.3	3000
10120	7/8" x 14	29.8	6.2	9.2	2500
11000	1 1/16" x 12	33.9	5.9	9.0	2000
11001	1 5/16" x 12	40.3	6.0	9.4	1500

BOUCHONS FILETÉS

Bouchon anti-vibration

SR 6112

Polyéthylène basse densité transparent

- Idéal pour les applications hydrauliques
- Filets crénelés pour prévenir la perte du bouchon du fait des vibrations
- Couleur transparente pour une inspection facile du joint
- Le bouchon assure un maintien serré sur le tube

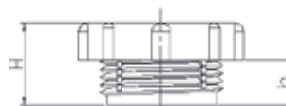

Référence	Taraudage BSP (mm)	Dimensions (mm)		Qté par sac
		H	h	
110826	1/4" x 19	11.0	5.0	500
110827	3/8" x 19	12.8	6.8	500
110829	1/2" x 14	13.3	7.3	500
110828	5/8" x 14	16.5	10.5	500
110830	3/4" x 14	15.6	9.6	500

Bouchons filetés BSP

SR 1054

Polyéthylène basse densité rouge

- Convient pour les tailles BSP les plus courantes
- Pose et dépose rapide
- Recommandé pour les raccords hydrauliques

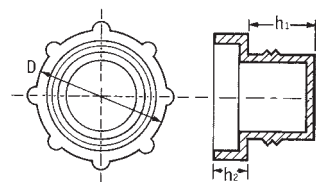

Référence	Taraudage	Dimensions (mm)			Qté par sac
		D	h1	h2	
10097	1/4" x 19	17.0	4.5	6.0	5000
10098	3/8" x 19	21.0	6.3	6.0	5000
10099	1/2" x 14	27.0	6.8	6.0	3000
10548	5/8" x 14	28.0	9.6	6.0	2500

Bouchons filetés

SR 1077

Polyéthylène basse densité rouge

- Tête moletée pour un montage facile
- Idéal pour une étanchéité dans les logements biseautés à 37°

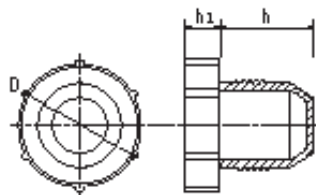

Référence	Taraudage UNF/JIC	Dimensions (mm)			Qté par sac
		D	h	h1	
110228	5/16" x 24	13.9	10.7	6.3	12000
110177	3/8" x 24	15.3	11.9	6.4	8500
110178	7/16" x 20	17.2	14.1	6.4	6500
110179	1/2" x 20	17.2	13.7	6.3	6500
110180	9/16" x 18	20.4	12.6	6.4	4500
110181	5/8" x 18	20.8	14.5	6.4	4500
110182	3/4" x 16	24.1	18.6	6.5	2200
110183	7/8" x 14	27.0	21.1	6.5	1800
110184	1 1/16" x 12	34.7	21.8	6.5	1200
110185	1 1/16" x 14	34.0	24.6	6.4	1000
110186	1 5/16" x 12	40.9	23.5	6.3	1400

Bouchon fileté NPT

SR 5759

PEHD - rouge

- La tête moletée permet une vissage et dévissage facile
- Utilisé pour protéger le filetage contre les contaminants et l'humidité



Paroi de 0,050" (1,27 mm)
Cette zone uniquement

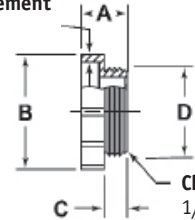

Chanfrein
1/32" x 45°
(0,79 mm)

Référence	Pour filetage	Dimensions (mm)				Qté par sac
		A	B	C	D	
PT1/4A	1/4"	12.7	18.4	5.7	11.2	9000
PT3/8A	3/8"	12.7	22.9	5.7	14.9	6500
PT1/2A	1/2"	12.7	28.5	6.4	17.8	4000
PT3/4C	3/4"	12.7	33.0	6.4	23.9	3000
PT1A	1"	12.7	39.8	6.4	30.0	1800

Cape percée pour tuyau

SR 5758

PEBD jaune

TPE noir

- Appliqué aux extrémités de tubes et de tuyaux afin de les empêcher de glisser sur les fixations

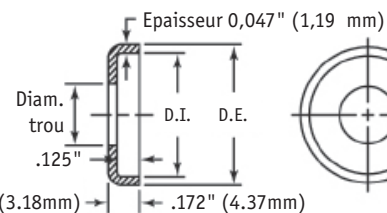

Référence		Dimensions (mm)			Qté par sac
PEBD	TPE	Ø trou	D.I.	D.E.	
W6A	W6C	8.1	15.0	17.4	19000
W8A	W8C	11.3	19.3	21.8	12000
W10A	W10C	14.6	22.1	24.6	10000
W13A	W13C	17.8	26.4	29.0	6500
W15A	W15C	21.0	29.6	32.2	5000
W20A	W20C	26.7	33.0	35.6	5000

Bouchon pas gaz

SR 5757

Nylon 6 - Naturel

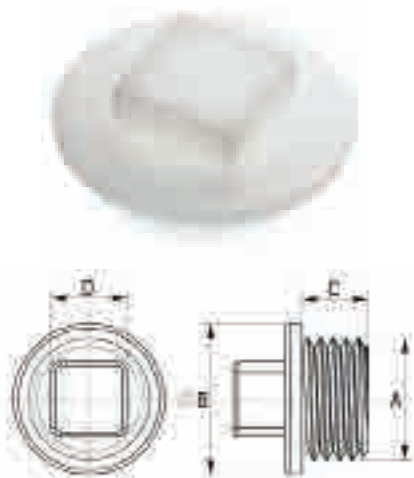

- Bouchon filetage gaz de 1/8" jusqu'à 1 1/4"
- Résistant à la corrosion et à de nombreux agents chimiques

Référence	Dimensions (mm)				Qté par sac
	A	B	C	D	
075012500001	G1/8	13.0	7.0	9.0	50
075025000001	G1/4	16.0	7.0	11.0	50
075037500001	G3/8	21.0	8.0	12.5	50
075050000001	G1/2	27.0	9.0	14.0	50
075075000001	G3/4	34.0	11.0	17.0	50
075100000001	G1	41.0	11.0	19.0	50
075125000001	G1 1/4	53.0	11.0	24.0	50

Bouchon Absorbant

Polypropylène jaune/ Fibres bicomposants

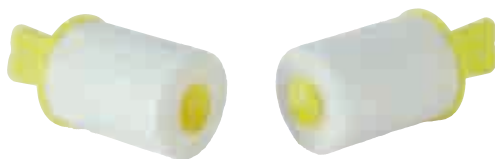

- Absorbe les résidus de fluide, évite les fuites et contaminations
- Forme spécifique permettant une pose et un retrait rapide.
- Plus sur et plus propre qu'un bouchon conventionnel. Ce bouchon ne laisse aucun résidu dans les filetages ou trous.
- Disponible pour filetages et trous lisses en dimensions métriques BSP et UNF
- Très bonne résistance chimique
- Autres dimensions possibles sur demande pour quantités importantes

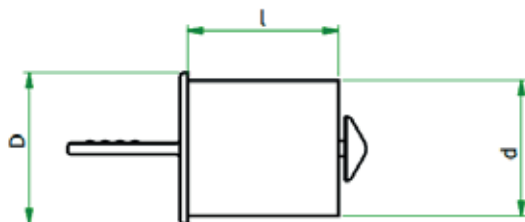

Référence	Pour filetage			Dimensions (mm)			Absorption**	Qté par sac
	Métrique	BSP	UNF	D	d	l		
1342611	M10 x 1.5	1/8" x 28	3/8" x 24	10.7	8.5	15.0	0.54	1000
1342612 *	M10 x 1.5	1/8" x 28	3/8" x 24	10.7	8.5	25.0	0.89	1000
1342613	M12 x 1.5	-	-	12.5	10.5	15.0	0.86	1000
1342614 *	M12 x 1.5	-	-	12.5	10.5	25.0	1.43	1000
1342615	-	1/4" x 19	-	13.6	11.5	15.0	1.05	1000
1342616 *	-	1/4" x 19	-	13.6	11.5	25.0	1.76	1000
1342617 *	M14 x 1.5	-	9/16" x 18	14.5	12.5	15.0	1.02	1000
1349120	M14 x 1.5	-	9/16" x 18	14.5	12.5	20.0	1.36	1000
1342618	M14 x 1.5	-	9/16" x 18	14.5	12.5	25.0	1.70	1000
1342619	M16 x 1.5	-	5/8" x 18	16.5	14.5	15.0	1.48	1000
1342620 *	M16 x 1.5	-	5/8" x 18	16.5	14.5	25.0	2.46	1000
1342621 *	M18 x 1.5	-	-	19.0	17.0	15.0	2.14	1000
1342622	M18 x 1.5	-	-	19.0	17.0	25.0	3.57	1000
1342623 *	-	3/8" x 19	-	17.2	15.0	15.0	1.65	1000
1342624	-	3/8" x 19	-	17.2	15.0	25.0	2.75	1000
1349119	-	-	-	20.0	18.0	20.0	3.25	1000
1342625	M20 x 1.5	1/2" x 14	-	20.8	18.5	25.0	4.32	1000
1342626	M22 x 1.5	5/8" x 14	-	22.8	21.0	25.0	5.60	1000
1342627	-	3/4" x 14	1-1/16" x 12	26.5	24.6	25.0	8.04	1000
1342628	-	1" x 11	-	32.5	30.5	35.0	17.68	1000

*Les valeurs varient suivant les substances et les viscosités

Bouchons Slottex

SR 1005

Polyéthylène basse densité jaune

- Montage et démontage avec un tournevis ou une clé, avec un outillage électrique ou à la main

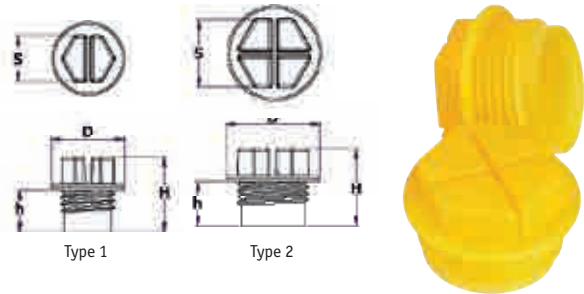

Métrique

Référence	Taille de filetage	Type	Dimensions (mm)				Qté par sac
			D	H	h	S	
110860	M8 x 1	1	12.0	14.2	7.0	7.0	5000
110861	M10 x 1	1	14.0	13.2	6.0	9.0	5000
110862	M12 x 1	1	16.0	16.2	9.0	10.0	5000
110863	M12 x 1.5	1	16.0	16.2	9.0	10.0	5000
110864	M14 x 1.5	2	19.0	16.2	9.0	13.0	5000
110865	M16 x 1.5	2	21.0	17.2	10.0	15.0	3000
110866	M18 x 1.5	2	24.0	18.2	10.0	17.0	3000
110867	M20 x 1.5	2	16.0	20.2	12.0	19.0	3000

BSP/Gaz

Référence	Taille de filetage	Type	Dimensions (mm)				Qté par sac
			D	H	h	S	
110868	1/8" x 28	1	14.0	16.2	9.0	9.0	5000
110869	1/4" x 19	2	19.0	16.2	9.0	13.0	5000
110870	3/8" x 19	2	21.0	17.2	10.0	15.0	5000
110871	1/2" x 14	2	26.0	20.2	12.0	19.0	3000
110872	3/4" x 14	2	32.0	20.2	12.0	24.0	2000
110873	1" x 11	2	40.0	20.2	12.0	30.0	1500
110874	1 1/4" x 11	2	49.0	20.2	12.0	36.0	800

Bouchons d'étanchéité Slottex

SR 1007

Nylon 6 jaune

- Etanchéité grâce au double joint situé sous la collerette
- Pose facile & rapide à l'aide d'un tournevis, d'une clé Allen
- Peut-être serré manuellement ou avec un outil pneumatique
- Tête conçue de manière à ne pas retenir de liquide

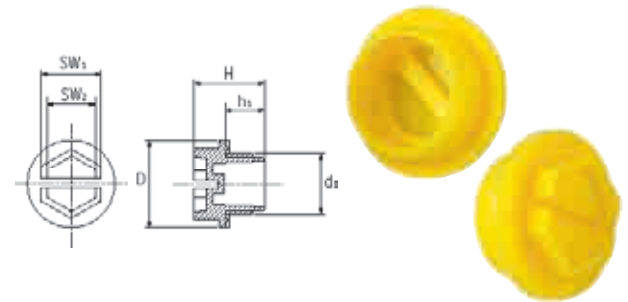

Filetage métrique

Référence	Filet (d1)	Dimensions (mm)					Qté par sac
		D	H	h1	SW1	SW2	
462836	M8 x 1	12.5	15.5	8.0	7.0	4.0	5000
462837	M10 x 1	14.5	16.5	9.0	9.0	6.0	5000
466973	M12 x 1	17.0	16.5	9.0	10.0	7.0	500
466974	M10 x 1.5	14.5	16.5	9.0	9.0	6.0	500
462838	M12 x 1.5	17.0	16.5	9.0	10.0	7.0	5000
110836	M14 x 1.5	19.0	17.5	10.0	13.0	10.0	1000
110837	M16 x 1.5	22.3	17.5	9.3	15.0	12.0	500
110838	M18 x 1.5	24.0	17.5	9.0	17.0	14.0	500
462842	M20 x 1.5	26.0	17.5	10.0	19.0	16.0	3000
110839	M22 x 1.5	28.0	17.5	10.0	21.0	18.0	500
466975	M24 x 1.5	30.0	17.5	10.0	24.0	21.0	500
466976	M26 x 1.5	32.0	20.5	12.0	24.0	21.0	500
466977	M27 x 1.5	33.0	20.5	12.0	24.0	21.0	500
466978	M28 x 1.5	34.0	20.5	12.0	24.0	21.0	500
466979	M30 x 1.5	38.0	20.5	12.0	24.0	21.0	500
466980	M32 x 1.5	40.0	20.5	12.0	24.0	21.0	500
466981	M36 x 1.5	45.0	20.5	12.0	24.0	21.0	500
466982	M38 x 1.5	48.0	20.5	12.0	24.0	21.0	250
466983	M45 x 1.5	52.0	21.5	12.0	30.0	27.0	250
466985	M27 x 2	33.0	22.0	13.5	24.0	21.0	250
466986	M30 x 2	38.0	22.0	13.5	24.0	21.0	250
466987	M33 x 2	40.0	22.0	13.5	24.0	21.0	250
466988	M36 x 2	45.0	22.0	13.5	24.0	21.0	250
466989	M42 x 2	50.0	22.0	13.5	30.0	27.0	250
466990	M45 x 2	52.0	22.0	13.5	30.0	27.0	125
466991	M48 x 2	55.0	23.0	13.5	30.0	27.0	100
466992	M52 x 2	60.0	23.0	13.5	30.0	27.0	100

Filetage BSP

Référence	Filet (d1)	Dimensions (mm)					Qté par sac
		D	H	h1	SW1	SW2	
110845	1/8" x 28	16.0	15.5	8.0	12.0	9.0	1000
110840	1/4" x 19	19.0	17.5	10.0	13.0	10.0	1000
110841	3/8" x 19	22.0	17.5	10.0	15.0	12.0	500
110842	1/2" x 14	27.0	19.5	12.0	19.0	16.0	500
466993	5/8" x 14	29.5	19.5	12.0	22.0	19.0	500
110843	3/4" x 14	32.0	19.5	12.0	24.0	21.0	250
110844	1" x 11	40.0	22.5	15.0	30.0	27.0	100
462853	1 1/4" x 11	50.0	22.5	15.0	36.0	33.0	1000
466995	1 1/2" x 11	56.0	24.0	15.0	41.0	37.0	250
466996	1 3/4" x 11	62.0	24.0	15.0	50.0	46.0	250
466997	2" x 11	68.0	24.0	15.0	55.0	51.0	100

Filetage UNF

Référence	Filet (d1)	Dimensions (mm)					Qté par sac
		D	H	h1	SW1	SW2	
466948	3/8" x 24	16.0	17.5	10.0	9.0	6.0	5000
466949	7/16" x 20	17.0	17.5	10.0	10.0	7.0	5000
466950	1/2" x 20	19.0	17.5	10.0	13.0	10.0	3000
466951	9/16" x 18	20.5	17.5	10.0	13.0	10.0	3000
466952	5/8" x 18	22.0	17.5	10.0	15.0	12.0	3000
466953	3/4" x 16	26.0	17.5	10.0	19.0	16.0	3000
466954	7/8" x 14	28.5	19.5	12.0	21.0	18.0	3000
466955	1" x 14	31.5	19.5	12.0	24.0	21.0	1000
466956	1 1/16" x 12	33.0	19.5	12.0	24.0	21.0	1000
466958	1 5/16" x 12	40.0	22.5	15.0	30.0	27.0	1000
466959	1 5/8" x 12	47.5	22.5	15.0	36.0	33.0	500
466960	1 7/8" x 12	54.0	22.5	15.0	36.0	33.0	500

Capés de protection filetés

SR 1018

Polyéthylène basse densité rouge

- Utilisées dans les industries automobile et hydraulique et en construction mécanique
- Protègent les composants filetés de la poussière, de l'humidité et contre les chocs durant la production, le stockage et le transport

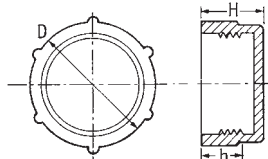

Métrique

Référence	Taille de filetage	Dimensions (mm)			Qté par sac
		D	H	h	
12100	M8 x 1	9.9	10.0	7.0	500
12101	M10 x 1	11.9	10.0	7.5	500
12102	M12 x 1	13.8	12.0	9.5	500
12103	M12 x 1.5	14.0	12.0	9.5	500
12104	M14 x 1.5	15.9	12.0	9.5	500
12650	M14 x 1.5	16.0	20.6	9.2	500
12105	M16 x 1.5	17.9	12.0	9.5	500
12651	M16 x 1.5	18.0	21.0	9.0	500
12106	M18 x 1.5	19.7	14.0	9.5	500
12107	M20 x 1.5	21.9	14.0	9.5	500
12108	M22 x 1.5	24.3	13.8	11.5	500
12845	M22 x 1.5	24.4	24.5	17.5	250
12109	M24 x 1.5	26.2	14.0	11.5	250
12110	M25 x 1.5	27.2	14.0	11.5	250
12111	M26 x 1.5	28.3	14.0	11.5	250
12967	M28 x 1.5	32.0	14.0	12.4	250
12122	M30 x 2	34.0	14.0	11.5	150
12123	M36 x 2	38.8	16.0	13.5	150
12124	M42 x 2	44.5	16.0	13.5	100
12126	M52 x 2	54.7	16.0	13.5	100

UNF/JIC

Référence	Taille de filetage	Dimensions (mm)			Qté par sac
		D	H	h	
10251	3/8" x 24	11.0	8.3	4.0	500
12652	7/16" x 24	13.3	13.7	7.8	500
10332	7/16" x 20	13.3	12.9	8.0	500
10528	1/2" x 20	14.5	13.5	9.5	500
11041	9/16" x 18	16.5	13.5	9.5	500
10653	5/8" x 18	18.2	15.6	7.5	500
12847	3/4" x 16	21.7	13.8	9.5	500
12825	13/16" x 16	23.3	15.3	9.3	250
11089	7/8" x 14	24.9	20.2	14.0	250
12075	7/8" x 18	25.3	20.0	14.0	250
12826	1" x 14	27.6	17.2	12.0	250
10685	1 1/16" x 12	29.4	19.0	11.0	200
10163	1 3/16" x 12	32.7	19.1	13.0	150
10151	1 5/16" x 12	36.4	22.2	14.5	100
12654	1 3/8" x 12	37.4	24.5	10.5	100
10185	1 7/16" x 12	38.9	21.7	15.2	100
11053	1 5/8" x 12	44.8	22.0	14.0	100
11804	1 7/8" x 12	50.3	25.0	15.0	100

BSP/Gaz

Référence	Taille de filetage	Dimensions (mm)			Qté par sac
		D	H	h	
10392	1/8" x 28	11.8	12.0	6.5	500
10559	1/4" x 19	14.8	11.0	8.0	500
10104	3/8" x 19	18.7	11.3	7.4	500
10198	1/2" x 14	23.2	13.5	7.0	500
11157	5/8" x 14	25.4	15.7	10.0	500
10205	3/4" x 14	29.4	17.7	11.2	250
10970	7/8" x 14	32.4	19.5	12.5	150
10204	1" x 11	36.0	19.0	14.5	100
10167	1 1/4" x 11	44.4	19.8	13.0	100
10432	1 1/2" x 11	50.3	20.5	14.0	100
10968	2" x 11	61.9	21.0	15.0	100
12905	2 1/2" x 11	77.9	27.6	19.0	50

Capés montage rapide

SR 1161

Polyéthylène basse densité rouge

- Le filetage de faible profondeur permet un montage rapide

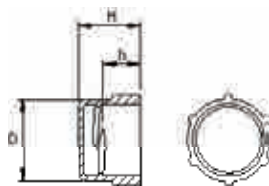

Référence	Taille de filetage	Dimensions (mm)			Qté par sac
		D	H	h	
464147	M12 x 1.5	14.0	12.0	7.5	5000
464148	M14 x 1.5	16.0	12.0	7.5	5000
464150	M16 x 1.5	18.0	12.0	7.5	5000
464151	M16 x 1.5	18.0	21.0	6.5	5000
464152	M18 x 1.5	20.0	14.0	9.5	4000
464153	M20 x 1.5	22.0	14.0	9.5	4000
464154	M22 x 1.5	24.5	14.0	9.5	2000
464155	M24 x 1.5	26.5	14.0	9.5	2000
464156	M26 x 1.5	28.5	14.0	9.5	2000
464157	M28 x 1.5	32.0	14.0	9.5	2000
464158	M30 x 2.0	34.0	14.0	9.0	1500

Capés filetés d'étanchéité

SR 1126

PEHD jaune

- Matière PEHD robuste permettant de réduire les risques de déchirure
- Joint en caoutchouc néoprène limitant les risques de fuite
- Serrage manuel recommandé
- Une empreinte hexagonale permet le montage avec un outil à faible couple de serrage



Métrique

Référence	Taraudage	Dimensions (mm)					Qté par sac
		D	H	h	SW1	SW2	
467033	M8 x 1	12.0	13.0	11.0	10.0	11.0	500
467034	M10 x 1	14.2	13.0	11.0	12.0	13.2	500
467035	M12 x 1	16.5	13.0	11.0	14.0	15.4	500
467036	M12 x 1.5	16.5	15.0	13.0	14.0	15.4	500
467037	M14 x 1.5	18.5	15.0	13.0	16.0	17.5	500
467038	M16 x 1.5	21.0	15.0	13.0	18.0	19.7	500
467039	M18 x 1.5	23.0	15.0	13.0	20.0	21.9	500
467040	M20 x 1.5	25.0	15.0	13.0	22.0	24.1	500
467041	M22 x 1.5	27.5	15.0	13.0	24.0	26.3	250
467042	M24 x 1.5	30.0	15.0	13.0	26.0	28.5	250
467043	M25 x 1.5	31.0	15.0	13.0	27.0	29.6	250
467044	M26 x 1.5	32.0	15.0	13.0	28.0	30.7	250
467045	M28 x 1.5	34.0	15.0	13.0	30.0	32.9	250
467046	M30 x 1.5	36.5	15.0	13.0	32.0	35.1	250
467047	M30 x 2	36.5	17.0	15.0	32.0	35.1	250
467048	M36 x 1.5	44.5	16.0	14.0	39.0	42.8	100
467049	M36 x 2	44.5	18.0	16.0	39.0	42.8	100
467050	M42 x 2	51.0	18.5	16.0	45.0	49.4	100
467051	M45 x 1.5	54.5	16.5	14.0	48.0	52.6	100
467052	M45 x 2	54.5	18.5	16.0	48.0	52.6	100
467053	M52 x 2	62.0	18.5	16.0	55.0	60.3	100

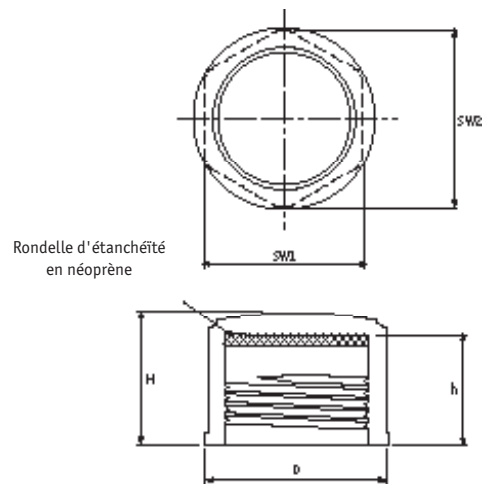

UNF

Référence	Taraudage	Dimensions (mm)					Qté par sac
		D	H	h	SW1	SW2	
467054	1/4" x 28	10.0	13.5	11.5	8.0	8.8	500
467055	3/8" x 24	13.0	14.5	12.5	11.0	12.1	500
467056	7/16" x 24	15.5	14.5	12.5	13.0	14.3	500
467057	7/16" x 20	15.5	15.0	13.0	13.0	14.3	500
467058	1/2" x 20	17.5	15.0	13.0	15.0	16.5	500
467059	9/16" x 18	18.5	15.5	13.5	16.0	17.5	500
467060	5/8" x 18	21.0	15.5	13.5	18.0	19.7	500
467061	3/4" x 16	24.0	16.5	14.5	21.0	23.0	500
467062	13/16" x 16	26.5	16.5	14.5	23.0	25.2	500
467063	7/8" x 18	27.5	15.5	13.5	24.0	26.3	500
467064	7/8" x 14	27.5	17.5	15.5	24.0	26.3	250
467065	1" x 14	31.0	17.5	15.5	27.0	29.6	250
467066	1 1/16" x 12	34.5	18.5	16.5	30.0	32.9	250
467067	1 3/16" x 12	36.5	18.5	16.5	32.0	35.1	250
467068	1 5/16" x 12	41.0	18.5	16.5	36.0	39.5	250
467069	1 3/8" x 12	43.0	18.5	16.5	38.0	41.7	250
467070	1 7/16" x 12	45.5	18.5	16.5	40.0	43.9	250
467071	1 5/8" x 12	51.0	19.0	16.5	45.0	49.4	100
467072	1 3/4" x 16	54.5	17.0	14.5	48.0	52.6	100
467073	1 7/8" x 12	59.0	19.0	16.5	52.0	57.0	100

BSP

Référence	Taraudage	Dimensions (mm)					Qté par sac
		D	H	h	SW1	SW2	
467074	1/8" x 28	14.0	13.0	11.0	12.0	13.2	500
467075	1/4" x 19	17.5	15.0	13.0	15.0	16.5	500
467076	3/8" x 19	22.0	15.0	13.0	19.0	20.8	500
467077	1/2" x 14	27.0	17.0	15.0	24.0	26.0	500
467078	5/8" x 14	29.0	17.0	15.0	25.0	27.4	500
467079	3/4" x 14	32.0	17.0	15.0	28.0	30.7	250
467080	7/8" x 14	36.0	17.0	15.0	32.0	35.1	250
467081	1" x 11	41.0	19.0	17.0	36.0	39.5	250
467082	1 1/4" x 11	51.0	19.0	17.0	45.0	49.4	250
467083	1 1/2" x 11	56.0	19.5	17.0	50.0	54.8	100
467084	2" x 11	71.0	19.5	17.0	63.0	69.1	100
467085	2 1/4" x 11	80.0	19.5	17.0	70.0	76.8	100
467086	2 1/2" x 11	90.0	19.5	17.0	80.0	87.7	100